

€15.–

Your guide to laboratory and pathology equipment in Europe

LAB BOOK



- Automation & Sample Processing
- Chemistry & Immunochemistry
- Hematology
- Pathology
- DNA
- Microbiology
- POCT
- IT
- Other Applications

2021

Vol.8

Shed light on the mysteries of rare microbial infections with Zybio's 4th generation MALDI-TOF EXS2600 Mass Spectrometry System. Zybio EXS2600 series is tailored for microbiology laboratories by presenting accurate results, elevating efficiency and benefiting clinical research.





**FIGHTING THE
CORONAVIRUS
DRIVES YOU.**

**DELIVERING
HIGH-QUALITY
ASSAYS
DRIVES US.**

Access SARS-CoV-2 Serology Assays

T: +44 (0)1494 441181

E: infouk@beckman.com

W: [www.beckmancoulter.com/solutions/
sars-cov-2-antibody-testing](http://www.beckmancoulter.com/solutions/sars-cov-2-antibody-testing)





Dear readers,

2021 – the second year of a pandemic is coming to an end and it seems that over the course of the past months we have somehow lost the strength that characterized our initial answer to this challenge. In the beginning, we as societies faced the new challenge with solidarity as laboratory medicine methods and terms such as PCR or quick tests entered our daily vocabulary. But with enthusiasm and solidarity waning, laboratory medicine is once again relegated to the sidelines, at least in Germany. Even more importantly, objective lab results are being interpreted not only by physicians but also by lay-people with a political agenda.

Despite this somewhat pessimistic review and preview: welcome to the 2021 LABBook. Unsurprisingly, COVID-19 plays a prominent part in our lab medicine purchasing guide as manufacturers present their SARS-CoV-2 kits and our authors examine the topic from different angles. There is still no reliable patient-side quick test that performs near as well as the gold standard PCR. For 2022, Bernard Banga expects considerable efforts and developments in POCT analytics with improved test procedures and new platforms. "Lab-on-a-chip" technology will most likely provide devices linked to the smartphone and wearables.

Mass spectrometry continues to make a major contribution to diagnostics as Uta Ceglarek's report on newborn screening in Leipzig underlines. Established in 2005, the screening programme now encompasses 19 tests, 9 of which are performed on an MS/MS platform; PCR moreover recognizes further immunodeficiencies and spinal muscular atrophy (SMA). While not all diseases that are detected can be cured, an early diagnosis may significantly slow down their progression.

The European lab community is closely watching the political developments since not only mass spectrometry laboratory-developed tests (LDTs) are affected by the EU regulation on in vitro diagnostic medical devices (IVDR, (EU) 2017/746). Thomas Streichert outlines the risks and opportunities for patients, labs and manufacturers as well as the likely effects of Brexit.

Raquel Cumeras introduces us to ion mobility spectrometry, a new measurement principle which closes the gap between chromatography and mass spectrometry and thus opens up new application potential, e.g. in breath gas analysis and combining LC and IMS.

As usual, the LABBook – in print, as an e-paper or in our database – presents new as well as tried and tested lab instruments, software and supplies for all tasks in the medical laboratory, categorized in chapters ranging from automation and information technology to peripheral devices. All information contained in the LABBook is accessible online at www.labbook.eu and www.healthcare-in-europe.com where you will also find contact details of the manufacturers and authors.

Manufacturers, authors and the editorial team – we all look forward to receiving your feedback, be it praise, criticism or suggestions what you would like to find in the next edition.

Enjoy reading and browsing,

Dr Markus Neumann



4



16



46



64



10

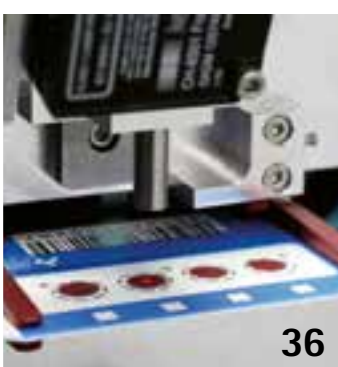

36



51

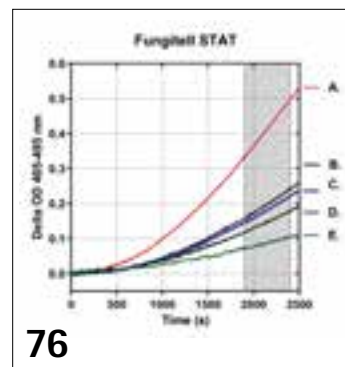

76

Trends & Topics

4 **IVDR – Watch out! Conflict ahead**
Next year might bring a shortage of several lab tests as many manufacturers struggle to comply with EU regulations.

10 **Hologic – Molecular scalable solutions**
Different diagnostic locations require solutions that meet different needs.

16 **Beckman Coulter – Minimizing laboratory errors**
Automation is key for minimizing time-consuming, costly mistakes.

36 **Shimadzu Europe – Fully automated and hematocrit-corrected phosphatidylethanol analysis**
The DBS autosampler with an embedded HCT scanner combined with LC-MS permits analysis of large sample volumes and correcting for the red blood cell volume percentage, without manual sample preparation.

46 **Siemens Healthineers – Chronic liver disease**
Non-invasive testing is essential due to the looming pandemic and benefits the growing demand for physician partnerships.

51 **Shenzhen Mindray – Taking morphology analysis to the next level**
New on the market: Automated Digital Cell Morphology Analyzer MC-80

64 **MolGen – Providing innovative molecular workflows to empower future diagnostics**
In the area of human and animal diagnostics applications, MolGen develops and globally markets advanced molecular total solutions.

76 **Associates of Cape Cod – Fungitell STAT explained**
Adjunct diagnostic assay to be utilized in conjunction with clinical signs and symptoms to diagnose invasive fungal infection.

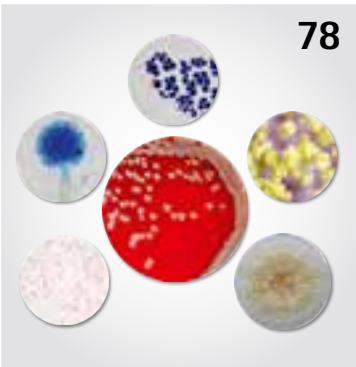

78



84



82



88

78 Zybio – Shed light on the mysteries of rare microbial infections by MALDI-TOF MS
The EXS2600 mass spectrometry system enables rapid microbial identification, including bacteria and fungi.

82 Early detection – New diagnostic possibilities with MS qPCR newborn screening
The range of diseases diagnosed through screening has increased significantly by using mass spectrometry (MS/MS) and lately qPCR.

84 Ion-mobility Spectrometry – Rapid results from breath analysis
IMS is flexible, portable and can be used for point-of-care testing or remotely.

88 Trends – Emerging technologies in POCT
Lab-on-a-chip platforms, innovations in smart-phone-based technology and wearable technology will drive POCT.

1 Editorial
106 Companies & Suppliers
113 Imprint



Products & Systems

7 Automation & Sample Processing
20 Chemistry & Immunochemistry
39 Mass Spectrometry
75
45 Hematology
57 Pathology
62 DNA
74 Microbiology
86 POCT
95 Information Technology
99 Other Applications

Watch out! Conflict ahead

In May 2022 a shortage of several lab tests may come as many manufacturers struggle to comply with EU regulation requirements covering in vitro diagnostic medical devices (IVDR, Regulation (EU) 2017/746). Even modified tests and laboratory-developed tests will present a problem for hospitals and labs as explained by Dr Thomas Streichert, Private Docent and Director of the Institute of Clinical Chemistry at the University Hospital Cologne, Germany.

Steps toward IVDR conformity

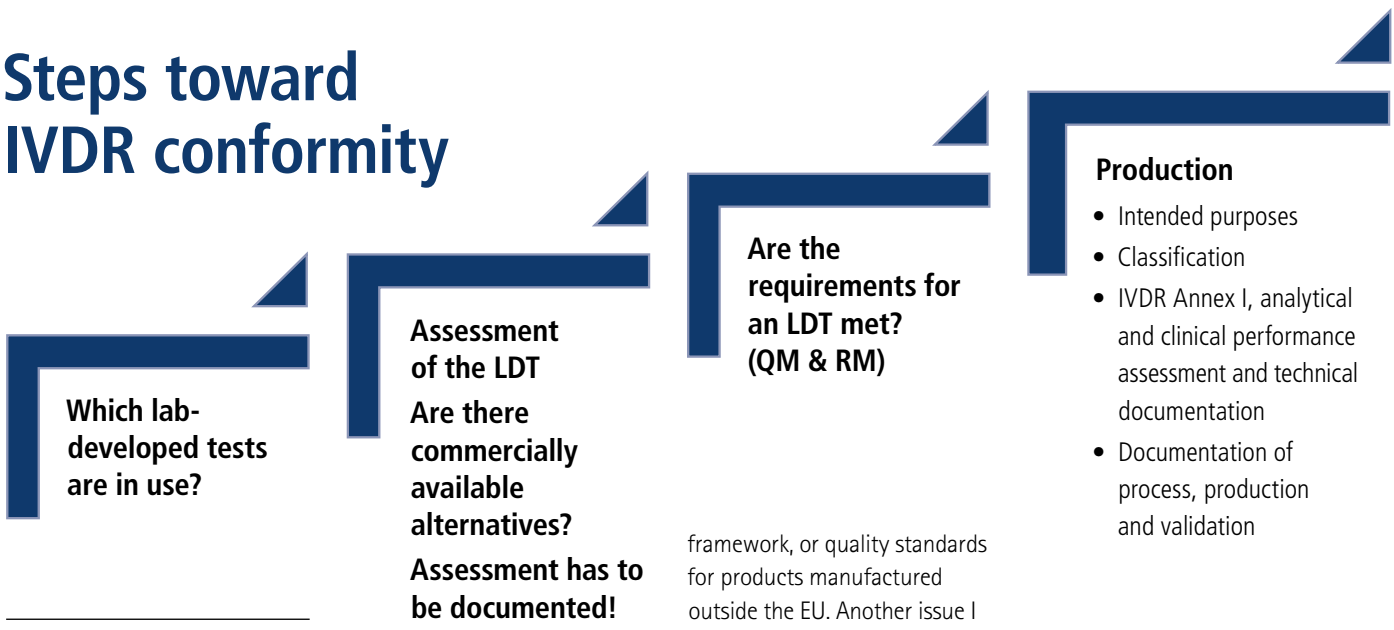

Which lab-developed tests are in use?

Assessment of the LDT
Are there commercially available alternatives?
Assessment has to be documented!

Are the requirements for an LDT met? (QM & RM)

Production

- Intended purposes
- Classification
- IVDR Annex I, analytical and clinical performance assessment and technical documentation
- Documentation of process, production and validation

Interview: Daniela Zimmermann
 Text: Michael Krassnitzer

In about six months, the EU regulation on in vitro diagnostic medical devices (IVDR) will apply. Lab managers, as well as experts in laboratory medicine, severely criticised the regulation. What are the problems?

In the worst case scenario next year many tests with CE mark that are currently used in labs and hospitals will no longer be available. We are facing a difficult situation and a major

challenge for the healthcare system.

What are the critical issues in IVDR?

IVDR contains many aspects that I consider important and correct: increased patient safety, classification of products according to risk, harmonisation of the conformity assessment procedure, supervision of the so-called notified bodies, harmonisation of the EU regulatory

framework, or quality standards for products manufactured outside the EU. Another issue I find very positive: in the future, clinical tests will be reviewed for clinical performance. That means each new test that's launched has to demonstrate its clinical value in performance evaluation studies, for example enhancement of a therapy.

Where's the hitch?

First, the time frame for implementation is rather short. The regulation came into force in 2017 and will apply as of 26 May 2022. While this transition period might sound long, it has turned out to be very ambitious,

in view of the infrastructure that must be established for the future approval of in vitro diagnostic devices. Moreover, a precondition for the regulation, the central data base EUDAMED, is not yet fully operational. In addition, there's a problem with the notified bodies that need to be involved in the conformity assessment of critical products: after Brexit there were only six rather than 18 notified bodies left in the EU. This creates a bottleneck that slows down the process.

According to a recent study under IVDR, a notified body has to be involved in about 78 percent of the approval procedure for in vitro diagnostic medical devices – up from previously eight percent.

You are referring to a MedTech Europe study which is quite enlightening in many aspects: it shows the substantial risk that, next year, many tests will no

Putting into service

longer be available. Particularly for rare diseases there are tests which are distributed by very small enterprises, often university spin-offs. For them, continuing to offer these tests might financially not be viable due to the high costs. If a manufacturer can no longer sell his tests as a CE-marked product, the test is still available on the market but the lab manager who purchased it has to validate the test and can be held liable. But validating a purchased test is pretty close to impossible.

We understand that tests developed by the labs themselves will also face difficulties. Can you explain the problems?

A university hospital uses on average 700 to 800 laboratory-developed tests – so-called LDTs. In the future, all these in-house tests will have to comply with IVDR standards.

This means a lot of work for hospitals and labs. The most problematic assays, in my opinion, are modified tests – i.e. commercially available assays where the labs deviate from the manufacturer's protocol, for example by using the test with a different matrix.

Conformity declaration (publicly accessible)

At the University Hospital Cologne we measure a certain tumour marker in CSF, not in serum or plasma as the manufacturer prescribes. Strictly speaking this is a significant modification, which means we are considered the manufacturer of this product. Consequently, we have to validate this test ourselves. However, to do so we'd need the technical details of the assay, for example where the antibody binds, and we'd need access to the relevant performance tests.

This is not only a time-consuming task but also requires the manufacturer to disclose this information. It might well happen that we have to discontinue using this test even though it is useful for the patients.

Could manufacturers adapt the intended purpose of their tests?

Manufacturers are not keen to do that. They are

currently busy making their tests IVDR-compliant by the deadline. If they modified the intended purpose they would also have to go through the conformity assessment procedure again.

Product monitoring / vigilance

There are also concerns that, in the future, labs will have to pay for tests that they themselves developed, but that are being distributed by an external company. Are these concerns justified?

At the University Hospital Cologne we use a number of mass spectrometry assays which we developed ourselves to measure medication levels. Today, a company is offering one of these tests in its product portfolio. If we want to comply with IVDR requirements with regard to the so-called industry privilege,



PROFILE

Dr Thomas Streichert is Director of the Institute for Clinical Chemistry, Medical Director of the Centre for Laboratory Diagnostics (Clinical Chemistry, Microbiology, Virology, Pharmacology, Endocrinology) and Interim Director of the Institute of Pharmacology, Therapeutic Drug Monitoring, at the University Hospital Cologne.

Born in South Africa, Streichert studied medicine in Hamburg where he also worked as junior physician and consultant. In 2013, the specialist physician for laboratory medicine joined the University Hospital Cologne.

He is chair of the E-Learning Commission at the University Hospital Cologne and member of the German Society for Clinical Chemistry and Laboratory Medicine (Deutsche Vereinigte Gesellschaft für Klinische Chemie und Laboratoriumsmedizin e.V.).



we have to clinically and technically validate the assay that we developed ourselves against the commercially available test. If the latter is as good as or better than our own test, then we have to discontinue using our test and purchase the commercial assay. But why should we use scarce resources to develop a test which two years down the road will be offered by a company and we will be forced to buy it?

How can this problem be solved?

By defining the intended purpose for the patient groups very narrowly and, at the same time, highlighting the benefits, e.g. useability in other matrices such as CSF. Even when we use a smaller sample than indicated by the manufacturer, our test is still better because it's better for the patient – less blood has to be drawn.

Thus I'm not too worried about the industry privilege. I think it will be rather unlikely that a manufacturer will insist on us using his test and threatening litigation. In order to do so he would have to show that his assay fully complies with the quality requirements of our in-house assay. That means he would have to disclose his development processes – which he rather wants to avoid. The pressure is not applied by the manufacturer but by the regulatory body. In general, the number of LDTs used will be much smaller.

Will this have financial consequences?

In-house developments are often significantly cheaper for labs. However, the comments on IVDR point out that economic considerations must not be the reason for the use of LDTs. Thus, the hospitals

have no incentive any more to develop their own tests. In the long run this will impair the ability of hospitals and labs to react in acute situations. During the pandemic, imagine if we would have had to wait for commercial manufacturers to offer Covid-19 tests.

What other difficulties will labs and hospitals have to face in the wake of IVDR?

The term in vitro diagnostic device was expanded to include software. While this is only one line in the regulation, it has immense consequences: software developers have to meet the same requirements as the manufacturers of lab products.

In next generation sequencing, human genetics or molecular tumour diagnostics labs use complex software solutions that integrate several test results. All these software

solutions must be reviewed to make sure they are not lab-developed items under IVDR. Hardly anybody has ever validated software – much less validated for IVDR conformity.

How can this issue be navigated?

I am chair of a sub-group in the Working Group of Scientific Medical Societies (Arbeitsgemeinschaft der Wissenschaftlichen Medizinischen Fachgesellschaften – AWMF), which deals exclusively with software issues in the context of IVDR. We compiled a guidance document for all those who develop such software solutions. After all, IVDR is not overly specific with regard to software, which gives us some room to manoeuvre. But the requirements exist and must be complied with. At the end of the day we will have to jump through that hoop.

Automation & Sample Processing



ASPLab
Automation
Automated Sample Processing



**BECKMAN
COULTER**



HOLOGIC



IMPROVE



MOLGEN



Promega



SARSTEDT



**SIEMENS
Healthineers**



**T&O
LABSYSTEMS**



zybio

Sample Processing
Automation
Sample Logistics

Sample Processing

Sample Processing

ASP Lab Automation – Bench-top Decapper DeCap Pro



Dimensions: 560 × 360 × 610 mm (w × h × d)
Sample throughput: over 2,000 tubes/h

Highlights:

DeCap Pro decapper is a compact bench-top device that safely and efficiently removes original caps from blood specimen tubes.

- Avoids potential health risks from Carpel Tunnel Syndrome and aerosol contamination
- Tubes are loaded and decapped in analyzer racks
- Handles up to 15 racks each for input and output
- Available for many analyzer rack types
- Robust and simple design guarantees high reliability and uptime
- Smaller models available that handle single racks

ASP Lab Automation – Recapper KapSafe



Dimensions: 730 × 730 × 1100 mm (w × h × d)
Sample throughput: up to 1,200 tubes samples/h

Highlights:

Automated recapping of sample tubes

KapSafe is an automated, pneumatics-free, high-speed, benchtop recapper designed to safely and automatically recap tubes for storage or archiving. The system recaps all standard vacuum collection tubes with 13 to 16 mm diameter and enables repeated automated decapping and recapping. It provides walkaway operations with an input capacity of up to 20 racks with various-sized tubes in each rack.

ASP Lab Automation – Tube Sorter SortPro



Dimensions: 1170 × 1870 × 601 mm (w × h × d) for six channels
+ 170 mm for each two extra channels

Sample throughput: more than 3,200 samples/h

No of Channels: freely configurable from 6 to 12 target bins
+ 1 error bin

Highlights:

SortPro saves medical and hospital laboratories' money, time and resources with its daily operation, based on the following features:

- Early specimen identification and registration
- Fast presorting of specimens
- Bulk input and bulk output of specimens
- Processes most blood and urine tube types
- Identifies specimen by barcode, cap color and/or tube type
- Priority handling for urgent tubes
- Identifies precentrifuged specimens
- Archives photos of all processed tubes

Sample Processing

Hologic – Novodiag System



Dimensions: 490 × 330 × 570 mm (w × h × d)
for one instrument configuration

Sample throughput: 1 – 128 tests per 24 hours

- Highlights:**
- The Novodiag System offers a simple and fast way to pinpoint patients most at risk with targeted and syndromic on-demand testing.
 - Offers a wide menu of targeted and multiplex assays in one instrument
 - Clear displays of results in around an hour
 - Small, quiet, fully automated easy-to-use platform
 - Up to four instruments can be stacked and controlled by a single computer (Novodiag PLUS)
 - Part of Hologic Molecular Scalable Solutions portfolio

Improve Medical – Automatic Biosafety Decapper



- Highlights:**
- Biosafety protection design
 - Micro-vibration design for specimen safety
 - Auto run and walk away with supporting sample-in and sample-out buffer zone
 - Aerosol filtration efficiency > 99.99%
 - A pf > 3 × 10⁵
 - Able to decap Φ 75/100mm tubes, even in one rack at the same time
 - Decapping throughput: > 1,800 tubes/h

MolGen – PurePrep TTR



- Highlights:**
- The PurePrep TTR offers high throughput automated liquid handling to quickly, accurately and consistently transfer liquid consistently from tubes to Deep Well microtiter plates.
 - Automated de-capping and capping of tubes
 - Processes up to 320 samples per hour
 - Liquid-level sensing
 - Full Track and trace of your samples
- The PurePrep TTR reduces contamination risk throughout the complete workflow

AD CORP 0011 V1.0 15-NOV-2021



Molecular Scalable Solutions – Meeting the Needs of Laboratories of all Sizes

One size does not fit all when it comes to diagnostics. Different diagnostic locations require solutions that meet their needs, whether that is on-demand testing in a healthcare setting or a laboratory managing population screening. Finding the right solution can be a challenge especially when the future may change what a laboratory needs.



CONTACT

Hologic, Inc
Heron House, Crewe Road,
Wythenshawe, Manchester M23 9HZ, Great Britain
phone: +44 161 946 2200
euinfo@hologic.com · www.hologic.com

Hologic Molecular Scalable Solutions are well placed to meet the growing diagnostics testing needs of laboratories of all shapes and sizes. From a single patient rapid result in about an hour to population level screening, meeting the molecular diagnostic needs of laboratories today and in the future.

The portfolio of systems has recently expanded with the addition of the on-demand, molecular-testing Novodiag® system, part of Hologic's Molecular Scalable Solutions portfolio. This system offers a simple fast way to pinpoint patients most at risk with targeted, multiplex and syndromic on-demand testing. Novodiag's high multiplex technology is precision engineered for simplicity, accuracy and affordability across a broad and growing menu of high and low plex assays to detect infectious diseases and for

antibiotic resistance management. It is a small, quiet, stackable, fully automated platform that combines easy to use functionality with molecular performance.

With just a few simple steps the Novodiag system enables fast, life-saving diagnoses, delivering precise, easy-to-read results in an hour, so improving efficiency and bringing clinical confidence closer to the patient. Infectious diseases are detected from a single use cartridge in about one hour and a comprehensive menu of assays for screening of antibiotic resistances, gastrointestinal, respiratory (including COVID-19) and hospital acquired infections is available. Each Novodiag assay can detect multiple targets simultaneously, for example, the Novodiag Bacterial GE+ assay has 14 targets, while the Novodiag Stool Parasites assay detects 26.

For settings that need a larger on-demand capacity, Novodiag Plus links up to four instruments. These can be stacked and controlled by a single computer and offer a total of four independent slots per instrument, adding flexibility and convenience.

For laboratories requiring systems with a higher throughput, Hologic's Panther® Scalable Solutions offer a range of options with a broad menu of high performing assays, allowing laboratories to expand their testing menu while adding on flexibility, capacity and walkaway time. The portfolio's foundation is the Panther system, which was launched in Europe in 2010. This offers random access and full automation for molecular testing with a broad assay menu including tests for women's health, sexually transmitted infections (STIs), respiratory health, and viral load, as well as Open Access functionality for laboratory developed tests (LDTs). This menu enables laboratories to consolidate molecular testing onto a single platform.

The Panther system has additional add-ons including Panther Fusion, which launched in 2016 and provides additional IVD menu and the Open Access™ functionality, the Panther Plus, Panther Link and Panther Trax*.

The Panther Fusion® module adds the ability to run real-time PCR, TMA and RT-TMA assays on a single, fully automated platform. This enables laboratories to consolidate testing, increase walkaway time and enhance flexibility.

With Panther Plus, laboratories can load more consumables directly on the instrument, allowing even greater walkaway time (up to 13.5 consecutive hours). Both fluids and waste can be changed while tests are in process, and an option for automatic liquid waste disposal is available. These features allow

an additional 210 tests to be run in 24 hours, providing a total throughput of greater than 1,200 patient samples in that time. Laboratories can gain additional efficiencies by using Panther Link, a software solution that creates a virtual connection allowing multiple Panther instruments to communicate with one another and function within a singular, streamlined workflow. Linked instruments can share information such as reagent kits and reflex test orders, enabling more efficient reagent utilization and improved turnaround time. A dashboard command feature allows technicians to monitor instrument inventories, maintenance tasks and test results on a single screen from a centralized location. Finally, the upcoming Panther Trax* will offer the ultimate in lab automation by physically and electronically linking multiple Panther instruments together into a single, powerful workcell that allows labs to increase testing volumes without increasing staff. Taken together, these configurable options address the needs of today's laboratories, allowing them to increase operational capacity and testing volumes at their own pace, while building on the flexibility and streamlined user experience they require. To find out more about how the Hologic's Molecular Scalable Solutions can meet the growing pressure and demands of today and tomorrow visit Hologic's website.

This is an advertorial by Hologic Inc.

*Not CE-IVD, not for sales.



Sample Processing

Sample Processing

MolGen – PurePrep FR



Highlights:

Compatible with downstream processing setups such as PCR and LAMP, the PurePrep FR is an automated liquid handler designed for filling plates with high precision.

- Easy to adjust to different procedures; customizable protocols
- Decreasing hands-on time
- Optimizing lab processes

The PurePrep FR makes defining new components simple, features multiple dispensing, mixing, and serial dilutions capabilities and offers insight into the results.

AD CORP 0012 V1.0 15-NOV-2021

Sarstedt – Decapper DC 1200 / Recapper RC 1200



Highlights:

Decapper DC 1200:

- Automatic decapping of all tube diameters from 11 to 16 mm
- Processes a variety of tube types in mixed operation
- Sample pre-sorting for the decapping process is unnecessary

Recapper RC 1200:

- Automatic recapping of all tube diameters from 13 to 16 mm
- Minimises the risk of exposure
- Eliminates sample contamination
- Archiving cap fits most tubes from 13 to 16 mm diameter
- Automated decapping enabled

Sarstedt – Bulk Sorter BL 1200



Highlights:

- Ideal in combination with any analytical platform
- Sample throughput up to 1,200 tubes/h
- Process any tube type of 80 to 110 mm length (with cap) and 11 to 16 mm diameter, including false bottom options
- Suited for any sample type (serum / plasma, serum gel / plasma gel, EDTA, citrate, blood sugar, urine)
- Intelligent re-routing when waiting for lab order
- Automatic sample accessioning
- Customised sort rules to a variety of carrier types or bins

System range:

- BL 1200 – Bulk to Rack
- HCTS2000 MK2 – Bulk to Box
- Sort Connect – Bulk to Track

Sample Processing

Sarstedt – Sample Distribution System PVS 1625



Highlights:

The PVS 1625 is a tailor made automation system for pre- and post-analytical processing of samples. It is capable to handle most kind of rack and tray types. As an open system, it is complementary to any analytical platform or can be used independently.

Full function pre- and post-analytical system

- Modular configuration according to laboratory needs with: Loading platform / ID Module / Decapper / Recapper / Aliquoter / Sorter
- For all common tube types:
 - 13 – 16 mm diameter, 65 – 100 mm length (without cap)
- Aliquoter for secondary tubes or multi-wells available

Sarstedt – Sorter DC/RC 900 Flex



Highlights:

Pre- and post-analytics in one system:

- Processes any tube diameter from 11 to 16 mm
- Sample throughput up to 900 tubes/h
- Compatible with most racks or carrier types
- Online or offline operation
- Opens tubes with push caps, stoppers and screw caps
- Can be customised to sort by tube type, material (barcode) or test request
- Closes tubes with universal archiving caps
- Retrofitting of decapping or recapping module is possible
- Recapping with screw caps for Sarstedt tubes with 13 or 15 mm diameter

Sarstedt – Sort Connect



Highlights:

- Sort Connect – Bulk feeding of samples with universal connection to laboratory track systems
- Process optimization with pre sorting and separation of tubes not destined for testing on the track
- Modular design enables a range of configurations
- Sample accessioning
- Intelligent sample re-routing where test order is missing
- Freely configured sorting platforms
- Automatic distribution to all common makes of analyser racks or into bins
- Can handle a large number of different tube types

Sample Processing

Sample Processing

T&O LabSystems – 4th generation ATRAS Bulk Loader and Bulk/Rack Sorter

- Dimensions:** 900 – 2900 × 1150 – 1390 × 600 – 675 mm (w × h × d)
- Sample throughput:** approx. 3,000 samples/h when sorting to bulk output bins
more than 1,000 samples/h per ATRAS Rack & Bulk Output module when sorting into racks or centrifuge buckets
- Channels:** Bulk Output only: 2 – 22 bulk output bins + 1 SIQ bin
Bulk Output + Rack & Bulk Output:
- 1 rack output platform + 5 to 19 bulk output bins + 1 SIQ bin
 - 2 rack output platform + 8 to 16 bulk output bins + 1 SIQ bin
 - 3 rack output platform + 11 to 13 bulk output bins + 1 SIQ bin

Highlights:

The ATRAS can be configured to perfectly fit your workflow and easily cope with your workload.

- Combination of bulk sorting with sorting into customer-specific racks and centrifuge buckets
- Fastest bulk to rack sorting on the market
- Option to extend the ATRAS with our intelligent sample transportation system InTrac

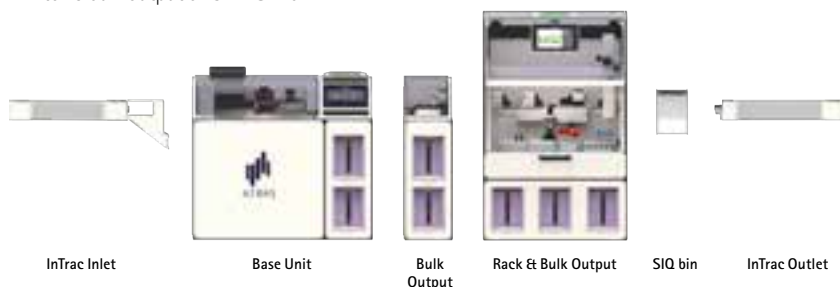

Zybio – M1000 Automated Liquid Pipetting Robotics



- Dimensions:** 750 × 560 × 810 mm (d × w × h)
- Sample throughput:** 16 sample tubes per load
- Tip loading/ejection:** automatic
- Daily Throughput:** over 3,500 samples
- Typical Application:** liquid pipetting, serial dilution, plate filling, pre-amplification setup

Highlights:

- Multi-functional with fast speed, as fast as within 4 minutes
- HEPA filter and UV system to eliminate aerosol pollutant
- Machine boot self-check, state self-check and auto error alarm
- Tip loading & ejection real-time monitoring
- Adopted with intelligent air pressure sensor as well as liquid level sensor, makes pipetting highly accurate

Automation

Beckman Coulter – DxA 5000

Sample throughput: up to 1,200 tubes/h



Highlights: The DxA 5000 helps laboratories meet the challenges of today's highly focused healthcare environment through a collection of patented innovations that deliver rapid and consistent turnaround time, provide a new level of comprehensive pre-analytical sample quality detection, and reduce the number of manual processing steps to significantly improve laboratory efficiency. Leveraging first-of-its-kind dynamic system software, the DxA 5000 utilizes Intelligent Routing to bring automated

patient-centric workflow to the laboratory. By understanding the tests requested, sample volume available and real-time analyzer capacity and status, the DxA 5000 continuously calculates the most expeditious route for every patient sample – both STAT and routine.

The DxA 5000 enhances Beckman Coulter's comprehensive portfolio of scalable solutions, and is a key component of its vision to bring workflow automation to laboratories of all sizes.

Automation

Beckman Coulter – DxA 5000 Fit

Sample throughput: up to 375 tubes/h

Highlights: At a time when up to 75 percent of lab errors take place pre-analytically, laboratories can benefit from comprehensive workflow automation. For this reason, Beckman Coulter developed the DxA 5000 Fit, an automation system that offers an improved approach to laboratory workflow by making intelligent automation accessible to labs of virtually any size. The DxA 5000 Fit leverages DxA 5000 technology, providing the benefit of intelligent automation to midsize labs in a compact footprint.

**Improve Medical – Intelligent Blood Collection Management Solution****Highlights:**

- Total solution for complete processes of blood collection management and sample processing
- Intelligent and standardized blood collection process
- Reduced errors during preanalytical phase

Component:

- Blood collection tube preparation system
- Intelligent sorter
- Multi-function blood collection table
- Queuing system

Promega – Maxprep Liquid Handler

Dimension: 1069 × 706 × 833 mm (w × h × d)
Weight: 98.6 kg
Sample throughput: 1 – 48 samples/hour;
 (2) 24 position Maxwell RSC 48/CSC 48 (RUO) or
 (2) 16 position Maxwell RSC/CSC (RUO) removable trays
Number of channels: 4
Assays: Promega Maxwell Kits

Highlights: Complete nucleic acid purification system in combination with Maxwell RSC/CSC (RUO) and Maxwell RSC 48/CSC 48 (RUO)

- Automated Maxwell sample preparation
- Hands-free nucleic acid extraction on the Maxwell RSC/CSC (RUO) or RSC 48/CSC 48 (RUO)
- Post-extraction sample preparation for quantitation, normalization and amplification setup using the Maxprep Liquid Handler
- UV decontamination and barcode scanner

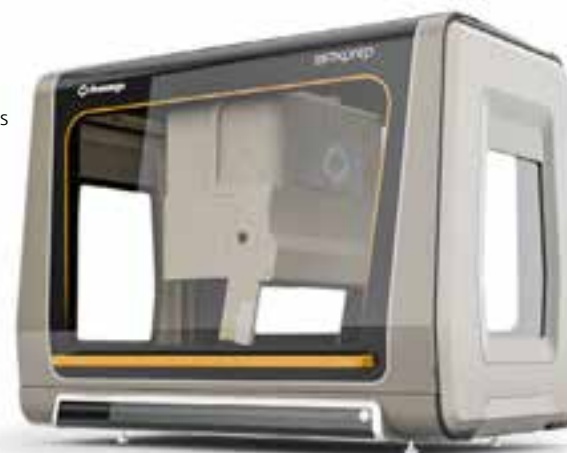

Minimising laboratory errors with automation

Staffing shortages, increased testing volumes and the need to improve turnaround times have led to labs seeking to streamline services. Automation is the key, thanks to the role it plays in minimising time-consuming, costly mistakes. Over recent years, several factors have led to labs struggling to meet demands, facing a need to speed up and streamline services in order to counteract staffing shortages, increased testing volumes and the need to improve turnaround times. This need has been especially highlighted during the COVID-19 pandemic, as

impacted labs have struggled to keep up with the daily demands of COVID-19 testing. Faced with these challenges, labs have pinpointed a particular area of improvement: the reduction of errors in testing. Read on to find out why.

Laboratory testing is widely relied upon when it comes to making a diagnosis. In fact, estimates suggest that 70 percent of all healthcare decisions affecting diagnoses or treatment involve laboratory testing.¹ When critical lab results are the basis of clinical decisions, reducing both pre- and post-analytical errors is of paramount importance.



Beckman Coulter – DxA 5000



Beckman Coulter – DxA 5000 Fit



Beckman Coulter – DxA 5000 Fit

The biggest problem lies in pre-analytical errors, which account for up to 70 percent of all mistakes made in laboratory diagnostics.⁴ Of these, it has been found that 24–30 percent of laboratory errors influence patient care, while actual or potential patient harm as a result of errors is registered in 3–12 percent of cases.^{5,6,7} These numbers show the desperate need faced to reduce these errors to improve patient care and avoid mistreatments across the board. In addition to their impact on patient care, however, laboratory errors are also costly. According to research, a laboratory in the US can expect to incur approximately \$180,000 per year in costs related to pre- and post-analytical errors, on average, with these errors including labelling mistakes, incorrect samples and insufficient sample volumes.^{8,9} Many of the errors detected in labs can be put down to one simple cause: human error. This means the solution is clear: automation.

Automation can play a key role

Automation is key to minimising time-consuming errors and is a necessity for any lab striving to meet the ever-evolving demands faced. In streamlining services by helping mitigate bottlenecks in the sample preparation phase, automation cuts down on the time spent on each test, speeding up the service. However, it also reduces person-to-person variation and human error in lab testing, substantially cutting down on mistakes and leading to more accurate results across the board.

Reducing the time overworked personnel spends on testing by implementing ways to automate pre- and post-analytical phases of routine laboratory testing also, however, provides labs with an additional benefit: it enables technologists to focus their time on analytics and reporting, harnessing their expertise and allowing them to apply it where it's needed most, therefore improving their analysis of results and, again, reducing errors further.

Implementing ways to automate pre- and post-analytical phases of routine laboratory testing also enables technologists to focus their time on analytics and reporting. In addition, automation helps mitigate bottlenecks faced when preparing samples by processing samples quicker, more efficiently, and more consistently than ever before.

Convinced that automation is the next necessary step for your laboratory?

Visit our automation page to view our full suite of automation solutions: www.beckmancoulter.com/en/products/automation.

Sources

1. Badrick T. (2013) Evidence-Based Laboratory Medicine. *Clin Biochem Rev.* 2013 Aug; 34(2): 43–46
2. Bonini P, Plebani M, Ceriotti F, Rubboli F. Errors in laboratory medicine. *Clin Chem* 2002;48:691–8.
3. Astion ML, Shojana KG, Hamil TR, Kim S, Ng VL. Classifying laboratory incident reports to identify problems that jeopardize patient safety. *Am J Clin Pathol.* 2003;120(1): 18–26. doi: 10.1309/8EXC-CM6Y-R1TH-UBAF.
4. Lippi G, Chance JJ, Church S, Dazzi P, Fontana R, Giavarina D, et al. Preanalytical quality improvement: from dream to reality. *Clin Chem Lab Med.* 2011;49:1113–26. doi: 10.1515/CCLM.2011.600.
5. Carraro P, Plebani M. Errors in a stat laboratory: types and frequencies 10 years later. *Clin Chem.* 2007 Jul; 53(7):1338–42. doi: 10.1373/clinchem.2007.088344.
6. Plebani M. The detection and prevention of errors in laboratory medicine. *Ann Clin Biochem.* 2010 Mar; 47(Pt 2):101–10. doi: 10.1258/acb.2009.009222.
7. Plebani M, Carraro P. Mistakes in a stat laboratory: types and frequency. *Clin Chem.* 1997 Aug; 43(8 Pt 1):1348–51.
8. Barak M, Jaschek R. A new and effective way for preventing pre-analytical laboratory errors. *Clin Chem Lab Med.* 2014 Feb;52(2):e5–8. doi: 10.1515/cclm-2013-0597. PMID: 24096442.
9. Green SF. The cost of poor blood specimen quality and errors in preanalytical processes. *Clin Biochem.* 2013 Sep;46(13–14):1175–9. doi: 10.1016/j.clinbiochem.2013.06.001. Epub 2013 Jun 14. PMID: 23769816.



CONTACT

Beckman Coulter Diagnostics
22, Rue Juste-Olivier
1260, Nyon, Switzerland
phone: +41 22 365 38 08
PAUEMarketing@beckman.com
www.beckmancoulter.com

Automation

Siemens Healthineers – Aptio Automation



Highlights:

Aptio Automation combines intelligent technologies with Siemens Healthineers workflow expertise in adaptable, multidisciplinary track designs with intelligent routing, single-sample flow and primary tube sampling. Choose from a selection of pre- and post-analytical processing modules and automation-ready chemistry, immunoassay, hematology, hemostasis and specialty testing analyzers. Broad connectivity to third-party instruments, including molecular, is also supported. Our experts perform data-driven simulations, optimization modeling and more to design and monitor your solution for ongoing productivity.

Siemens Healthineers – Atellica Task Targeted Automation*



Highlights:

Atellica Task Targeted Automation* delivers one-touch sample preparation to streamline open, multidisciplinary workflows in smaller labs and hub-and-spoke laboratory networks. Customize functionality to automate up to 12 key tasks. Change predefined operating modes throughout the day. Expand, retrofit, and/or move the compact cabinet as needs change. Rely on our experienced workflow consultants, who have improved off-track processes as part of 2200+ automation projects, to streamline mixed testing in labs with limited space.

* Distributed by Siemens Healthcare Diagnostics Inc.
Product availability varies by country and cannot be guaranteed.

Siemens Healthineers – Atellica Integrated Automation



Highlights:

Atellica Integrated Automation provides integrated automation in 6 m². By integrating automation into Atellica Solution* chemistry and immunoassay analyzers with little or no additional footprint, labs can automate several tasks associated with chemistry and immunoassay testing. The system provides intelligent software, decapping, and independent control over samples with the system's revolutionary sample management, including management of samples throughout all phases of testing – from sorting through archiving.

*Product availability varies by country.

Sample Logistics

Sarstedt – Tempus600 Vita

**Highlights:**

The Tempus600 Vita provides dedicated, direct and fast transport of blood samples to the laboratory without batching or manual packaging steps. The samples are placed in the insertion point of the Vita, transported via a pipeline \varnothing 25 mm and landed in the laboratory within seconds. Drastically reducing the total turnaround time for blood sample testing results in faster diagnosis and patient treatment.

- Handles up to 810 sample tubes/hour
- Compatible with all sample tubes: length 80 – 110 mm, diameter 12 – 18 mm
- Connectable to all lab automation, sorters and bulk loaders

Sarstedt – Tempus600 Quantit

**Highlights:**

The Tempus600 Quantit provides direct and fast transport of blood samples to the laboratory without batching or manual packaging steps. The samples are placed in a drawer, transported via a pipeline \varnothing 25 mm and landed in the laboratory within seconds. Drastically reducing the total turnaround time for blood sample testing results in faster diagnosis and patient treatment.

- Sending both high volume and urgent samples
- Samples are always oriented the right way by the system
- Compatible with all test tubes: length 80 – 110 mm, diameter 12 – 18 mm
- Connectable to all lab automation, sorters and bulk loaders

Sarstedt – Tempus600 Connection Module

**Highlights:**

The Tempus600 Connection Module is part of an automated one-touch handling system for sample tubes. The sample tubes are delivered from the ward to the laboratory through the dedicated point-to-point system. The sample tubes are gently slowed down before landing in the automation module. From here they are automatically transferred e.g. onto a track system.

- Compatible with all lab automation systems including sorters and bulk loaders
- A brake module can be fitted to increase sample throughput and failure-free tube loading.
- Up to 8 connections

Chemistry & Immunochemistry

Clinical Chemistry
Immunochemistry
Immunoassays
Integrated Systems
Mass Spectrometry
Electrophoresis /
Chromatography
Plasma Protein Testing
Drug Testing
Urine Screening
Urine Microbiology
Saliva Collection
Rapid Testing
CSF and Alzheimer's
Disease Diagnostics
Research Use Only

ALSACHIM
a Shimadzu Group Company



DIRUI

FUJIFILM

Genrui



greiner
BIO-ONE

mindray

 **SARSTEDT**

Lifotronic

 **SHIMADZU**
Excellence in Science

SIEMENS
Healthineers 

Snibe
Diagnostic

 **zybio**

Clinical Chemistry

Alsachim – Dosimmune immunosuppressant kit (CE-IVD or RUO)



Highlights: Immunosuppressants in whole blood for LC-MS/MS

Dosimmune is a reagent kit based on LC-MS/MS analytical method for the quantification of immunosuppressant drugs in whole blood: Cyclosporin A, Sirolimus, Everolimus, Tacrolimus.

Dosimmune is a turnkey diagnostic device for the rapid and multiplex assay of four immunosuppressant drugs, thanks to inhouse production of stable isotope-labelled internal standards. This multiplex method allows pharmacological therapeutic monitoring of patients treated with immunosuppressants.

Alsachim – Dosingaco anticoagulant reagent kit (RUO)



Highlights: Dosingaco is the first commercial LC-MS/MS reagent kit for anticoagulants in plasma.

Anticoagulants are used to treat and prevent blood clots prevalent in cardiovascular diseases. Direct oral anticoagulants (DOACs) have recently been developed, aiming to modulate factor X in a dose dependent manner. Their precise quantification is necessary to determine the concentration or to identify the presence/absence of an anticoagulant.

Alsachim – Dosimyco immunosuppressant reagent kit (RUO)



Highlights: Dosimyco, a ready-to-use reagents kit for the quantification of MPA and its metabolite MPAG in plasma by LC-MS/MS.

Mycophenolic acid is an immunosuppressant drug used to prevent rejection in organ transplantation and also for the treatment of autoimmune diseases. Dosimyco enables simultaneous quantification of mycophenolic acid and its metabolite mycophenolate glucuronide in plasma by LC-MS/MS, based on MRM technology and the use of stable labeled internal standards developed by Alsachim.

Beckman Coulter – AU5800 Series



Dimensions: 1260 × 2600 × 1580 mm (h × w × d)
Weight: 1,070 kg
Sample throughput: 2,000 – 9,800/h
Power consumption: 200 – 240 W

Highlights: The AU5800 series represents the highest throughput and fastest turnaround time in the Beckman Coulter AU chemistry analyzer family. With true random-access capabilities, the AU5800 series is available in four different scalable models, which are designed to meet the needs of the high-volume core hospital laboratories, as well as the ultra-high-volume commercial laboratory market segment.

- Maximize throughput with an intelligent sample management system that optimizes the processing of racks based on the tests ordered
- Ensure quick turnaround time for critical patients with STAT priority testing and auto-repeat of abnormal results

Clinical Chemistry

Beckman Coulter – DxC 700 AU



Dimensions: 1300 × 1250 × 890 mm (h × w × d)
Weight: 460 kg
Sample throughput: 800 – 1,200/h
Power consumption: 200 – 240 W

- Highlights:** Designed to meet the needs of mid- to high-volume clinical laboratories, the DxC 700 AU reduces the number of test-processing steps by 30 percent due to its intuitive user-interface that allow operators to spend less time on daily tasks and more time producing the quality results that empower better decision-making.
- Simple, intuitive design of the DxC analyzer with the robust throughput capabilities of the AU analyzer
 - Configurable with a total laboratory solution option to connect the DxC 700 AU with pre-analytical automation, immunoassay and clinical IT

Beckman Coulter – HbA1c Advanced



Highlights: The fully automated HbA1c Advanced assay enables mid- to high-volume laboratories to provide physicians with state-of-the-art precision and accuracy for diagnosing diabetes mellitus, monitoring long-term glucose control in individuals with diabetes mellitus and identifying patients who may be at risk of developing diabetes mellitus.

- National Glycohemoglobin Standardization Program (NGSP) certified/DCCT standardized and precise, providing clinically relevant results for diagnosing and monitoring diabetes
- Unaffected by common hemoglobin variants, minimizing misdiagnosis or missed diagnosis for patients with these blood conditions
- Easy to implement and integrate into the laboratory's existing chemistry testing practices, providing workflow efficiency
- Available in a single all-in-one kit for Beckman Coulter DxC 700 AU analyzers

Dirui – CS-T240Plus Auto-Chemistry Analyzer



Dimensions: 744 × 703 × 530 mm (d × w × h)
Weight: 100 kg
Sample throughput: 240 tests/h, 480 tests/h with ISE unit
Sample reagent positions: 40–80

- Highlights:**
- Whole blood test for HbA1c item
 - Water consumption only 3 L/h
 - Minimum reaction volume only 100 µL

Fujifilm Wako – Hyaluronic Acid LT Assay



Assays: Quantitative determination of Hyaluronic Acid (HA) based on the latex agglutination method

- Highlights:**
- Measurement of key marker for fibrotic stage of chronic liver diseases
 - Method applicable to general analyzers of clinical chemistry
 - Fast determination of hyaluronic acid in serum or plasma (10 min)
 - High precision

Clinical Chemistry

Fujifilm Wako – NEFA-HR(2) Assay



Assays: Quantitative determination of non-esterified fatty acids (NEFA) in serum

- Highlights:**
- Applicable to all common clinical chemistry analyzers and manual methods
 - Reliable results without interference from ascorbic acid and bilirubin
 - High linearity
 - Accurate, precise, simple and fast
 - Also applicable in veterinary samples

Fujifilm Wako – Autokit Total Ketone Bodies Assay



Assays: Quantitative determination of total ketone bodies [acetoacetate (AcAc) + 3-hydroxybutyrate (3-HB)] in serum or plasma

- Highlights:**
- Enzymatic colorimetric test, applicable to clinical chemistry analyzers
 - Recognition of pediatric metabolic disorders
 - Monitoring of liver transplants
 - Monitoring of diabetic patients
 - Reliable results without interference from ascorbic acid and bilirubin

Greiner – Vacuette CAT Serum Fast Tube



- Highlights:**
- Tube combines the speed of a plasma tube with the properties of serum
 - Shorter preanalytical process
 - Full coagulation in just 5 minutes
 - Improved turnaround time
 - Blood collection can be performed shortly before transport of the blood samples
 - Quicker lab results with on-site analysis

Mindray – BS-240Pro Clinical Chemistry Analyzer



Dimensions: 860 × 550 × 660 mm (w × h × d)
Weight: 115 kg
Sample throughput: Constant 240 tests/h, up to 400 tests/h with ISE

- Highlights:**
- Constant throughput with 240 photometric tests/h, up to 400 tests/h with ISE module
 - Large and flexible capacity: up to 100 sample/reagent positions (50 fixed + 50 interchangeable)
 - Reduced reagent consumption: 100 µl minimum reaction volume
 - Intelligent probe with liquid level detection, V&H collision detection, inventory monitoring, reagent pre-heating and optional clog detection
 - Grating photometer with 12 wavelengths, dual-diaphragm and dual-lens
 - HbA1c smart-sampling function, automatic hemolysis

Clinical Chemistry

Mindray – BS-430 Clinical Chemistry Analyzer



Dimensions: 1050 × 1150 × 720 mm (w × h × d)

Sample throughput: Constant 420 tests/h, up to 626 tests/h with ISE

- Highlights:**
- Large loading capacity: 92 reagent positions, 102 sample positions
 - HbA1c smart sampling: supports HbA1c onboard hemolysis
 - Advanced software platform: auto QC, auto reflex, substrate depletion & enzyme linearity extension, etc.
 - Quick start-up time: 5 minutes system initialization, 1 minute system wake-up
 - Low reagent consumption: minimal 100µl reaction volume

Mindray – BS-480 Clinical Chemistry Analyzer



Dimensions: 1185 × 1150 × 710 mm (w × h × d)

Weight: 300 kg

Sample throughput: Constant 400 tests/h, up to 560 tests/h with ISE

No of parallel samples: up to 78 on-board chemistry tests

- Highlights:**
- Discrete, random access, fully automated
 - Constant throughput with 400 photometric tests/h, up to 560 tests/h with ISE
 - 24-hour on board refrigerated reagent compartment at 2~10 C
 - Reusable cuvettes with auto-washing station
 - Two independent mixing stirrers
 - Clot detection, automatic probe cleaning, liquid level detection & collision protection (V&Eh)
 - Reversed grating system with 12 wavelengths (340~800nm)
 - Pre-dilution and post-dilution for sample
 - Built-in barcode scanner
 - Bi-directional LIS interface

Mindray – BS-800M Clinical Chemistry Analyzer



Dimensions: 1600 × 1200 × 1015 mm (w × h × d)

Weight: ≤ 450 kg for analytical unit, 150 kg for SDM

Sample throughput: Constant 800 tests/h, up to 1,200 tests/h with ISE

No of parallel samples: up to 68 on-board chemistry tests

- Highlights:**
- Modular system: flexible connection
 - HbA1c smart sampling, automatic hemolysis
 - Accurate: high pipetting precision, coolant circulation reagent refrigeration direct solid-heating system, effective mixing unit and intelligent clot detection
 - Innovative: reagent bubble detection, dot light source and water quality monitor
 - Cost-efficient: large capacity with SDM racking system, 100 µl minimum reaction volume, one key STAT, continuous reagent loading and unloading
 - Original calibrators with traceability

Mindray – BS-2800M Modular System



Dimensions: 2450 × 1150 × 1300 mm (d × w × h) (Single module + SD)

Sample throughput: M1 (2,000 T/H, up to 2,400T/H with ISEs) M2(4,000 T/H, up to 4,800T/H with ISEs)

Power Consumption: 220±10% V 50 Hz±1Hz
M1 ≤ 5,200VA / M2 ≤ 9,800VA

Reagent position: 144 positions (M1)

Sample position: 300

- Highlights:**
- High efficiency and quick tests for STAT
 - Modular design & high throughput
 - 1 min quick response and 8 mins quick report for STAT tests
 - High reliability and accuracy of results
 - Sample probe ultrasonic wash; PDR optical platform
 - HILL innovation solution
 - Real-time monitoring atmospheric pressure
 - Smart design, easy to operate and less manual intervention
 - Independent PAD for reagent management
 - IF & Reddot design award winner 2021

Clinical Chemistry

Sarstedt – S-Monovette GlucoExact



- Highlights:**
- The S-Monovette GlucoExact stands for precise determination of glucose and stabilizes the glucose concentration immediately for up to 96 hours at room temperature.
 - It meets the Gestational Diabetes Guidelines of the German Diabetes Association (DDG) and the German National Disease Management Guidelines (NVL) for type 2 diabetes.
 - Gold standard for glucose determination.

Sarstedt – S-Monovette Lithium Heparin Gel⁺



- Highlights:**
- Laboratory results influence therapy decisions by 70 to 85 percent. For both the doctor and the patient, it is important that laboratory results are incorporated into therapy decisions quickly and without compromise.
 - The S-Monovette Lithium Heparin Gel⁺ guarantees reliable sample quality at a reduced TAT: The centrifugation time is reduced by up to 50 percent which enables faster therapy decisions. Also the equipment utilization is optimized at an improved workflow.

Sarstedt – S-Monovette – Venous Blood Collection



- Highlights:**
- S-Monovette – the Revolution in blood collection. A blood collection system that combines two blood collection techniques – the aspiration technique and the vacuum technique.
 - The S-Monovette is suitable for all vein conditions and achieves an optimal sample quality, thereby producing the best results.
 - The aspiration technique is a gentle technique for routine blood collection. Using the vacuum technique, a "fresh" vacuum is always available.
 - Suitable for all ages, from young to old, the S-Monovette is as individual as your patients.

Sarstedt – Microvette – Capillary Blood Collection



- Highlights:**
- Flexible capillary blood collection systems such as the Microvette – tailor-made to the individual needs of each patient group.
 - Different patient groups and collection techniques require different collection systems.
 - With a nominal volume range from 100 – 500 µl, the capillary blood collection systems product range is one of the most extensive in the entire market.
 - Depending on the requirements, our portfolio includes Microvettes with conical or round bottom inner tubes and the option for various different collection techniques, end-to-end or with a collection rim.

Zybio, est. in 2008, is a high-tech enterprise specialized in IVD instruments and reagents' R&D, manufacture, sales and technical services, headquartered in Chongqing Municipality, China.

Development



Around 15% of annual revenue is continuously invested to R&D as well as innovative attempts.



Zybio has over 3,200 employees worldwide, including 1,000+ R&D personnel accounted for 30%.

Sales Turnover during 2015-2020

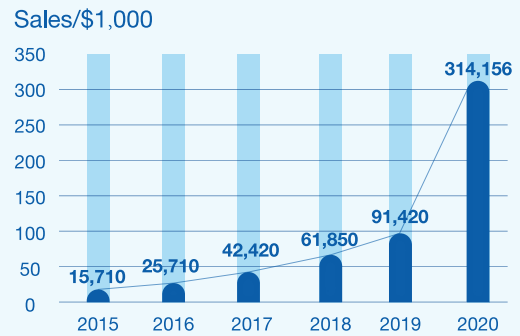

8 R&D Centers in China

Chongqing R&D center

Shanghai R&D center

Guangzhou R&D center

Shenzhen R&D center

Beijing R&D center

Nanjing R&D center

Xiamen R&D center

Changchun R&D center

International Marketing Network

5 continents

100+ countries

Benefiting 30,000+ end users

Main Products-instrument

Products consist of clinical chemistry, chemiluminescence immunoassay, molecular biology, hematology, microbiology, pathology and POCT

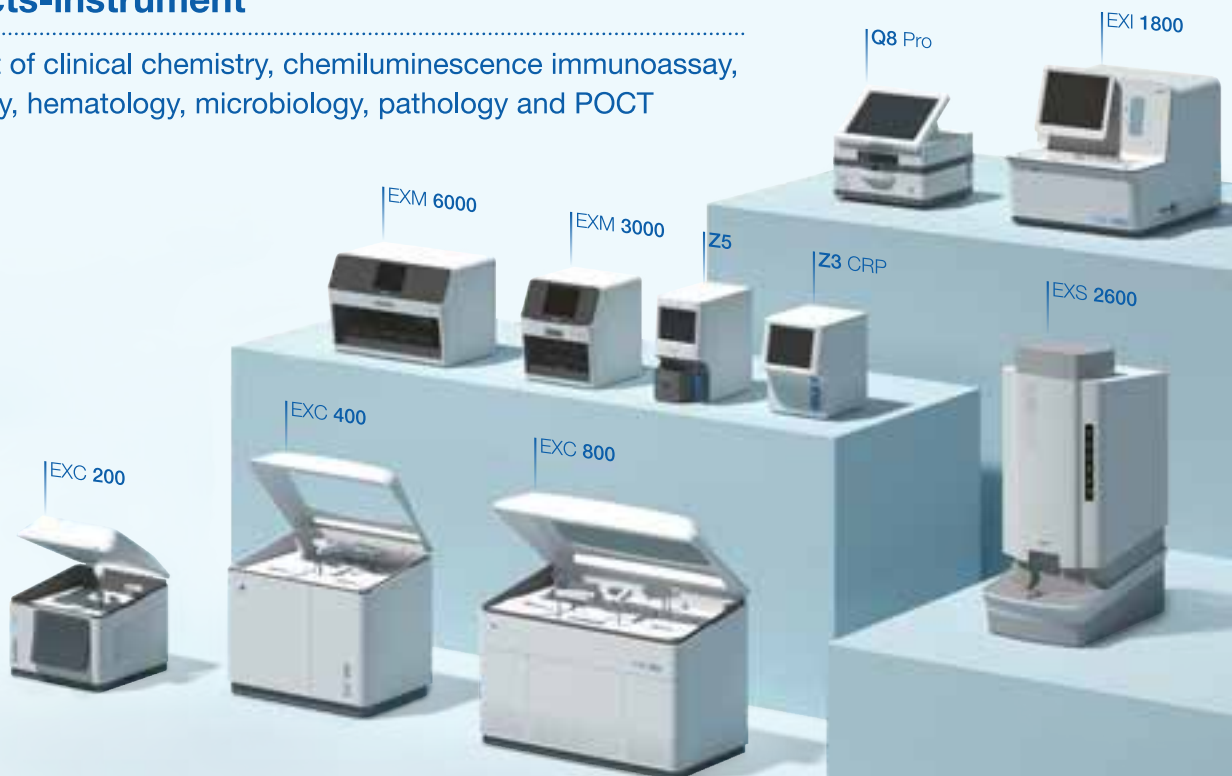

Clinical Chemistry

Snibe – Biossays 240 Plus Automatic Biochemistry Analyzer



- Dimensions:** 730 × 500 × 620 mm (w × d × h)
Weight: 68 kg
Sample throughput: 240 tests/h
Assays: 68
- Highlights:** Compact design – meets your needs of space and cost-saving
- 16 wavelengths range from 340–800 nm
 - Close system and open system is optional
 - Low water consumption (≤2.0-3.0 L/H)
 - Random access, continuous loading
 - 100 µL minimum reaction volume
 - Unlimited STAT position
 - ISE module (optional)

Snibe – Biossays E6



- Dimensions:** 450 × 510 × 597 mm (w × d × h)
Weight: 38 kg
Sample throughput: 300 tests/h
Assays: 5

- Highlights:** The fully-automatic new era of iCa²⁺ solution. Automatic puncture sampling method realizes anaerobic measurement to ensure the stability of ionized calcium levels and the accuracy of measurement
- Fully automatic sample loading and puncture sampling liberate hands
 - Connectable to total laboratory automation system*
 - Hedging type full pipettor cleaning to avoid cross-contamination
 - 5 electrodes as per request of any combination (Cl⁻, K⁺, iCa²⁺, PH, Na⁺)

*Available soon

Zybio – EXC200 Chemistry Analyzer



- Dimensions:** 710 × 705 × 635 mm (w × d × h)
Weight: 65 kg
Sample throughput: 240 tests/h for single reagent; 160 tests/h for dual reagents
Assays: 97 original reagents which cover hepatic, renal, lipids, diabetes, electrolyte, specific proteins and more
- Highlights:** EXC 200 is a benchtop chemistry analyzer which only needs 0.5 m² and yet does not compromise on performance. It combines versatile advanced functions that facilitate high-quality testing. EXC is a discrete and random-access clinical chemistry analyzer offering a throughput of 240 t/h for single reagent and 160 t/h for dual reagents. Working with 97 original chemistry reagents, EXC 200 is an ideal clinical solution for small healthcare sites.

Zybio – EXC400 Chemistry Analyzer



- Dimensions:** 1250 × 820 × 1100 mm (w × d × h)
Weight: 200 kg
Sample throughput: Constant 400 tests/h
Assays: 97 original reagents which cover hepatic, renal, lipids, diabetes, electrolyte, specific proteins and more
- Highlights:** EXC400 is a floor-stand automated chemistry analyzer. It combines versatile advanced functions which facilitate high-quality testing, improve turnaround time and cut operating costs. 97 original chemistry reagents are now available to meet the different demands. Working with the comprehensive reagent EXC400 is an ideal solution for mid-volume chemistry analysis.

Immunochemistry

DRG Instruments – DRG:Hybrid-XL

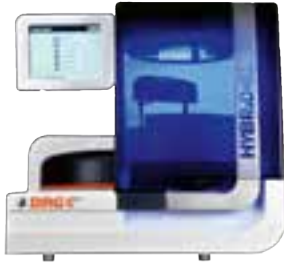

- Sample throughput:** Turnover of approx. 120 samples/day, fully automated
- Assays:** Antibiotic Treatment Control (TDM): Ceftazidim, Linezolid, Ciprofloxacin and other intensive care unit (ICU) parameters
- Dimensions:** 600 × 600 × 630 mm (w × h × d)
- Highlights:** Antibiotic Treatment Control (TDM) with DRG:Hybrid-XL DRG adds an important step in Antibiotics Stewardship:
- Fully automated quantitative analysis of antibiotics for therapeutic drug monitoring (TDM), other ICU parameters and more unique assays
 - Fast Results: no sample preparation, results in 1-1.5 h
 - Flexibility: up to 40 different parameters per sample in one run
 - Ease of Use: the intuitive user interface simplifies daily work
 - Secure: calibration is provided via master curve. Calibration and reagents offer a long stability.

Sarstedt – ELISA Plates / Micro test plates for immunoanalytics



- Highlights:** One of the analyses most commonly used is the Enzyme-Linked Immunosorbent Assay (ELISA). With this method, even the smallest concentrations of a range of substances (proteins, peptides, antibodies, hormones etc.) can be detected and quantified from complex solutions.

Immunoassays

Beckman Coulter – SARS-CoV-2 Assays



- Highlights:** The Access SARS-CoV-2 IgG (1st IS) assay and the Access SARS-CoV-2 IgM assay detect antibodies to the receptor-binding domain (RBD) of the spike protein which may be important to identify an immune response. Adding SARS-CoV-2 IgG (1st IS) and/or IgM testing to assess COVID-19 patients provides greater clinical clarity for patient assessment.
- Access SARS-CoV-2 IgG (1st IS) assay
 - The overall specificity of the Access SARS-CoV-2 IgG (1st IS) assay is 99.8 percent and the sensitivity ≥ 14 days post-symptom onset was 100 percent
 - Access SARS-CoV-2 IgM assay
 - The overall specificity of the Access SARS-CoV-2 IgM assay is 99.9 percent and the sensitivity > 18 days post symptom onset and post positive PCR was 100 percent

Beckman Coulter – Access High Sensitivity Troponin I (hsTnI)



- Highlights:** The Access hsTnI assay provides the advanced diagnostic capabilities necessary to aid physicians in diagnosing at risk patients for acute myocardial infarction earlier and discharging non-acute patients faster. In comparison to standard troponin assays, high-sensitivity assays demonstrate significantly improved precision at and below the 99th percentile upper reference limit (URL), allowing better discrimination of small differences in troponin values between serial measurements.
- Aids in rapid diagnosis of AMI and confidently excludes AMI in as little as one hour after patient presentation
 - Provides optimal precision at concentrations about 10x lower than previous generation troponin assays. Improved precision at the clinical cutoff reduces chance of misclassifying patients in the Emergency Department

Immunoassays

Beckman Coulter – Access Procalcitonin (PCT)



Highlights: Access PCT aids physicians in the risk assessment of critically ill patients for progression to severe sepsis or septic shock. With results you can trust in approximately 20 minutes. Access PCT allows healthcare providers to integrate procalcitonin testing into their routine sepsis workups on core laboratory analyzers as a primary or reflex test programmed through Beckman Coulter's REMISOL Advance middleware. Such integration simplifies laboratory workflow and optimizes institutional sepsis management protocols while reducing the operation expense of maintaining costly dedicated instrumentation.

Access PCT provides confidence in results and improved patient care through:

- >95 percent overall agreement with predicate method for accurate assessment of patients at risk of progression to severe sepsis and septic shock
- State-of-the-art sensitivity and low-end precision
 - 20 percent CV LoQ of 0.02 ng/mL
 - CV ≤ 8 percent at concentrations ≥0.150 ng/mL
- Minimal sample draw of 35 µl pick-up volume

Beckman Coulter – Access 2 Immunoassay System



Dimensions: 500 × 900 × 610 mm (h × w × d)
Weight: 91 kg
Sample throughput: up to 100/h
Assays: > 50 pre-programmed, bar-coded immunoassay methods

Highlights: Designed to have the robustness of a reference-lab immunoassay analyzer in the convenient size of a benchtop instrument, the Access 2 delivers quality, reliability and speed without sacrificing valuable floor space. The Access 2 features an extensive immunoassay diagnostic-testing menu of more than 50 tests including AMH and TSH (3rd IS).

- Standardized reagent and assay testing menus can be used across all immunoassay platforms to drive laboratory efficiency and provide consistent results across healthcare networks

Beckman Coulter – UniCel Dxl 800 Access Immunoassay System



Dimensions: 1700 × 1710 × 970 mm (h × w × d)
Weight: 630 kg
Sample throughput: up to 400 tests/h
Assays: > 50 preprogrammed, bar-coded immunoassay methods

Highlights: The UniCel Dxl 800 includes proven chemiluminescent technology and one of the highest throughput systems available on the market. High volume labs can decrease process steps and improve turnaround time by simplifying and automating immunoassay testing to a single platform.

- Beckman Coulter's immunoassay instruments have common software interfaces and consumables across the whole family, enabling operators to train more quickly, minimize inventory, and ensure consistency in results across platforms

Dirui – CM-180 Chemiluminescence Immunoassay Analyzer



Dimensions: 1230 × 757 × 554 mm (d × w × h)
SATA: Flexible emergency position
Sample throughput: 180 tests/h
Sample reagent positions: 25

Highlights:

- Individual cuvettes
- 180 tests/h excellent performance
- Avidin-acridinium ester chemiluminescence detection platform
- Humanized design, supports maximum of 25 parameters test simultaneously
- It can provide nearly 90 test items

Immunoassays

Fujifilm Wako – Autokit CH50 Assay



Assays: Quantitative determination of total complement activity (CH50) in human serum

- Highlights:**
- In vitro diagnostic homogeneous liposome immunoassay
 - Applicable to automated analyzers
 - Precise and accurate
 - Stable, extended calibration stability
 - Good correlation with Mayer's hemolytic method

Fujifilm Wako – μ TASWako i30



Dimensions: 520 × 550 × 600 mm (w × h × d)
Weight: 71 kg
Sample throughput: 25 tests/h
Assays: AFP/AFP-L3, DCP

- Highlights:**
- Electrokinetic Analyte Transport Assay (EATA)
 - High sensitive fluorescence detection
 - Assay precision less than 3% CV for AFP-L3
 - Increased sensitivity of liver cancer (HCC) detection by combined use of AFP, AFP-L3 and DCP
 - Unique system to calculate the GALAD score (Gender, Age, AFP-L3, AFP, DCP) for outstanding performance regarding early HCC recognition
 - Improved chance of detecting HCC early during surveillance of patients at risk

Genrui – PA120



Highlights: Trustable at its accuracy: PA120 is an auto specific protein analyzer with high efficiency and accuracy. Based on proven nephelometry, PA120 has great performance. Also, the large touch screen, one-press operation and multi-item combinations will offer you a fast and convenient testing experience.

Currently following tests are available: HbA1c, FDP, D-Dimer, NGAL, RBP, B2-MG, CYS-C, mALB, CRP, hs-CRP, SAA, IgA, IgM, IgG, IgE, C3, C4, ASO, RF, CCP, PG I, PG II
 More tests are in development

Lifotronic – Automated ECL Immunoassay Analyzer eCL 8000



Dimensions: 650 × 620 × 650 mm (h × w × d)
Weight: 92 kg
Sample loading capacity: 30 samples
Reagent loading capacity: 10 reagent kits
Reagent loading capacity: 86 tests/h

- Highlights:**
- Electrochemiluminescence (ECLIA) methodology
 - High accuracy and sensitivity
 - Wide application range
 - Perfect quality control system
 - Fully automatic operation
 - LCD color touch screen & concise interface
 - More than 60 kinds of reagent available
 - STAT parameters test time only 9 mins

Immunoassays

Lifotronic – Automated ECL Immunoassay Analyzer eCL 9000



Dimensions: 1282 × 1000 × 1665 mm (h × w × d)
Weight: 550 kg
Sample loading capacity: 150 samples + 15 STAT positions
Reagent loading capacity: 40 reagent kits
Reagent loading capacity: 300 tests/h

- Highlights:**
- Electrochemiluminescence (ECLIA) methodology
 - High accuracy and sensitivity
 - Wide application range
 - Perfect quality control system
 - Fully automatic operation
 - LCD color touch screen & concise interface
 - More than 60 kinds of reagent available
 - STAT parameters test time only 9 mins

Mindray – CL-900i Chemiluminescence Immunoassay System



Dimensions: 860 × 740 × 560 mm (w × h × d)
Weight: 130 kg
Sample throughput: up to 180 tests/h
No of channels: 15
Assays: 68

- Highlights:**
- High throughput up to 180 tests per hour
 - One of the smallest benchtop CLIA analyzer
 - Reagent capacity with 15 positions
 - Single cuvette system
 - Dual substrate and automatically switch the empty one
 - Intuitive software interface, easy access to all functions
 - Continuously loading of Intelligent consumables management reagents and consumables

Mindray – CL-1000i/1200i Chemiluminescence Immunoassay System



Dimensions: 1400 × 760 × 600 mm (w × h × d)
Weight: 225 kg
Sample throughput: up to 180 tests/h
No of channels: 25
Assays: 68

- Highlights:**
- High throughput up to 180 tests per hour
 - Benchtop analyzer
 - Large reagent capacity with 25 positions
 - Sample rack system
 - STAT lane
 - Single cuvette system
 - Dual substrate and automatically switch the empty one

Mindray – CL-2000i Chemiluminescence Immunoassay System



Dimensions: 2150 × 1020 × 1200 mm (w × h × d)
Weight: 750 kg
Sample throughput: up to 240 tests/h
No of channels: 36
Assays: 68

- Highlights:**
- High throughput: up to 240 tests per hour
 - Measurement principle: enhanced ALP-AMPPD method
 - Reagent carousel: 36 reagent positions with non-stop refrigerating
 - Sample handling: up to 300 samples can be loaded in one batch, sample loading and offloading continuously by sample racks, fast prioritizing STAT samples
 - Continuously loading of reagents, substrate, cuvettes, wash buffer and waste bags

Immunoassays

Mindray – CL-6000i Chemiluminescence Immunoassay System



Dimensions:	2150 × 1166 × 1300 mm (w × h × d)
Weight:	580 kg
Sample throughput:	up to 480 tests/h
No of channels:	36
Assays:	68

- Highlights:**
- Industrial highest throughput: up to 480 tests per hour
 - Measurement principle: enhanced ALP-AMPPD method
 - Reagent carousel: 36 reagent positions with non-stop refrigerating
 - Sample handling: up to 300 samples can be loaded in one batch, sample loading and offloading continuously by sample racks, fast prioritizing STAT samples
 - Continuously loading of reagents, substrate, cuvettes, wash buffer and waste bags
 - Zero daily maintenance

Mindray – CL-8000i Chemiluminescence Immunoassay System



Dimensions:	2305 × 1150 × 1180 mm (w × h × d) (Single module + SD)
Weight:	789 kg (Single module + SDM)
Sample throughput:	500 tests/h
Sample position:	300
Reagent position:	36
Assays:	67

- Highlights:**
- The CL-8000i is an upgraded immunoassay analyzer with high throughput up to 500T/H. CL-8000i helps improve medical quality and operational efficiency using technologies such as VU-Mix and FS-sampling. Easy-to-use designs such as one-key calibration quality control and quick reagent replacement greatly improve work efficiency.

Siemens Healthineers – Immulite 2000 XPI Immunoassay System



- Highlights:**
- Providing multiple tests on a single, easy-to-use analyzer – including allergy, specialty, and routine immunoassay testing – the IMMULITE 2000 XPI Immunoassay System makes it simple to scale your capabilities without disrupting regular day-to-day operations.
- Product availability varies by country.

Snibe – Maglumi X8



Dimensions:	1920 × 1180 × 1500 mm (w × d × h)
Weight:	670 kg
Sample throughput:	up to 600 tests/h (Single module) up to 2400 tests/hour (Four modules combined)
Assays:	181

- Highlights:**
- Fully compatible with Maglumi 181 parameters
 - Single-cup design can avoid the stuck of the cuvette and increase the cuvette utilization
 - Capable to link laboratory automation system (TLA/LAS)
 - No-pause loading / unloading of reagents, samples and consumables without waiting or interrupting tests
 - No cross-contamination sampling to ensure accurate results
 - Highly cost-effective with one pipetting for multiple tests technology

Immunoassays

Snibe – Maglumi X3



Dimensions: 900 × 750 × 780 mm (w × d × h)
Weight: 181 kg
Sample throughput: up to 200 tests/h
Assays: 181

- Highlights:**
- Small but powerful, the throughput is up to 200 tests/h and throughput per unit area is 294 T/h/m²
 - One of the highest space efficiency CLIA analyzers combines one of the broadest automated CLIA test menus (181 parameters)
 - Compatible with all Maglumi reagents
 - Single reaction cup can avoid light pollution and increase cuvette utilization, its integrated packaging can avoid the stuck of the cuvette and destroying the cuvette wall
 - No-pause loading/unloading of reagents/samples/reaction cups without waiting or interrupting tests

Snibe – Maglumi SARS-CoV-2 S-RBD IgG II (CLIA)



- Highlights:**
- New generation, wider range, better assessment
 - The fully automated quantitative serology test to detect IgG antibodies against S-RBD
 - Broad linear range from 0.375-1000 AU/mL
 - Assist in the diagnosis of the COVID-19
 - Assess the immune response to the COVID-19 after the natural infection and vaccination
 - Low sample volume of 10 µL
 - Diverse package specifications (50, and 100 tests per kit) to cover the testing needs of small labs to big hospitals

Snibe – Maglumi SARS-CoV-2 Neutralizing Antibody (CLIA)



- Highlights:**
- Addressing the urgent need of assessing immunity during the COVID-19 pandemic
 - An important tool of the COVID-19 vaccine efficacy assessment
 - Evaluating immunity in individuals and community to provide immunity "certification" for returning to society
 - Cost-effective and large-scale solution for neutralizing antibody test
 - Highly sensitive and specific detection of neutralizing antibodies: 100 percent positive agreement to gold standard

Zybio – EXI1800 Chemiluminescence Immunoassay Analyzer



Dimensions: 650 × 790 × 650 mm (w × d × h)
Weight: 110 kg
Sample throughput: up to 180 tests/h
Assays: Comprehensive test menu covers SARS-CoV-2, thyroid, fertility, inflammation, cardiac markers, diabetes, tumor markers and more

- Highlights:**
- EXI 1800 is a desktop automatic chemiluminescence immunoassay analyzer with compact design which only needs 0.52 m². With its patented magnetic separation technology, EXI1800 can effectively guarantee the precision and sensitivity of detection. It uses enzymatic chemiluminescence technology, labeled with ALP. The detection speed of EXI 1800 is 180 t/h. Its large consumable capacity contributes to the longest off-machine time, which is up to 3 hours. Easy maintenance system can do trouble shooting with one tap. The analytical module used on EXI1800 is a touch screen PC embedded with Window 10 operating system and user-friendly software, which makes your operation a lot easier.

Super High Throughput CLIA Analyzer

Fully-auto Chemiluminescence Immunoassay (CLIA) System

Fast CLIA
in the World **600T/H**



MAGLUMI® X8

200T/H



MAGLUMI® X3

MAGLUMI® Test Menu

Broadest CLIA Test Menu with 181 parameters

Thyroid

TSH (3rd Generation) ^{FDA}
T4 ^{FDA}
T3 ^{FDA}
FT4 ^{FDA}
FT3 ^{FDA}
Tg (Thyroglobulin)
TGA (Anti-Tg)
Anti-TPO
TRAb
TMA
Rev T3
*T-Uptake

Autoimmune

Anti-CCP
Anti-dsDNA IgG
ANA Screen
ENA Screen
Anti-Sm IgG
Anti-Rib-P IgG
Anti-Scl-70 IgG
Anti-Centromeres IgG
Anti-Jo-1 IgG
Anti-M2-3E IgG
Anti-Histones IgG
Anti-nRNP/Sm IgG
Anti-SS-B IgG
Anti-SS-A IgG
TGA(Anti-Tg)
Anti-TPO
TRAb
TMA
ICA
IAA(Anti Insulin)
GAD 65
Anti-IA2
Anti-MPO ^{NEW}
*ZnT8
*Anti-Cardiolipin IgG
*Anti-Cardiolipin IgM
*β2-Glycoprotein I IgG
*β2-Glycoprotein I IgM

Fertility

FSH
LH
HCG/β-HCG ^{FDA}
PRL (Prolactin)
Estradiol
Testosterone
free Testosterone
DHEA-S
Progesterone
free Estriol
17-OH Progesterone
AMH
SHBG
Androstenedione
*PIGF
*sFlt-1

Hepatic Fibrosis

HA
PIIIP N-P
C IV
Laminin
Cholyglycine

TORCH

Toxo IgG
Toxo IgM
Rubella IgG
Rubella IgM
CMV IgG
CMV IgM
HSV-1/2 IgG
HSV-1/2 IgM
HSV-1 IgG ^{NEW}
HSV-2 IgG
*HSV-2 IgM
*HSV-1 IgM

Tumor Markers

AFP
CEA
Total PSA
f-PSA
CA 125
CA 15-3
CA 19-9
PAP
CA 50
CYFRA 21-1
CA 242
CA 72-4
NSE
S-100
SCCA
TPA-snibe
ProGRP
HE4
HER-2
PIVKA-II

Prenatal Screening

AFP (Prenatal Screening)
Free β-HCG
PAPP-A
free Estriol

Glyco Metabolism

C-Peptide
Insulin
GAD 65
Anti-IA2
ICA
IAA (Anti Insulin)
Proinsulin
*Glucagon
*ZnT8

Cardiac

CK-MB
Troponin I
Myoglobin
hs-cTnl
H-FABP
NT-proBNP
BNP
D-Dimer
Lp-PLA2
MPO ^{NEW}
*HCY

Infectious Disease

HBsAg
Anti-HBs
HBeAg
Anti-HBe
Anti-HBc
Anti-HCV
Syphilis
Anti-HAV
HAV IgM
HIV Ab/Ag Combi
Chagas
HTLV I+II
H.pylori IgG
H.pylori IgA
H.pylori IgM
2019-nCoV IgG
2019-nCoV IgM
SARS-CoV-2 S-RBD IgG
SARS-CoV-2
Neutralizing Antibody
SARS-CoV-2 Ag
*Anti-HBc IgM
*Chlamydia Pneumoniae IgG
*Chlamydia Pneumoniae IgM
*Mycoplasma Pneumoniae IgG
*Mycoplasma Pneumoniae IgM

Coagulation Marker

D-Dimer
*TAT
*TM
*PIC
*tPAIC

Inflammation Monitoring

CRP (High Sensitive)
PCT (Procalcitonin)
IL-6 (Interleukin 6)
SAA (Serum Amyloid A)
*TNF-α

Hypertension

Direct Renin
Aldosterone
Angiotensin I
Angiotensin II
Cortisol
ACTH

Anemia

Vitamin B12
Ferritin
Folate (FA)
EPO ^{NEW}
*RBC Folate

Drug Monitoring

Digoxin
CSA (Cyclosporine A)
FK 506 (Tacrolimus)

Metabolism

Pepsinogen I
Pepsinogen II
Gastrin-17
GH (hGH)
IGF-I
IGFBP-3

EBV

EBV EA IgG
EBV EA IgA
EBV VCA IgG
EBV VCA IgM
EBV VCA IgA
EBV NA IgG
EBV NA IgA

Bone Metabolism

Calcitonin
Osteocalcin
25-OH Vitamin D ^{FDA}
Intact PTH
β-CrossLaps (β-CTX) ^{NEW}
total P1NP ^{NEW}

Immunoglobulin

IgM
IgA
IgE
IgG

Kidney Function

β₂-MG
Albumin
*NGAL

* Available soon

www.snibe.com sales@snibe.com



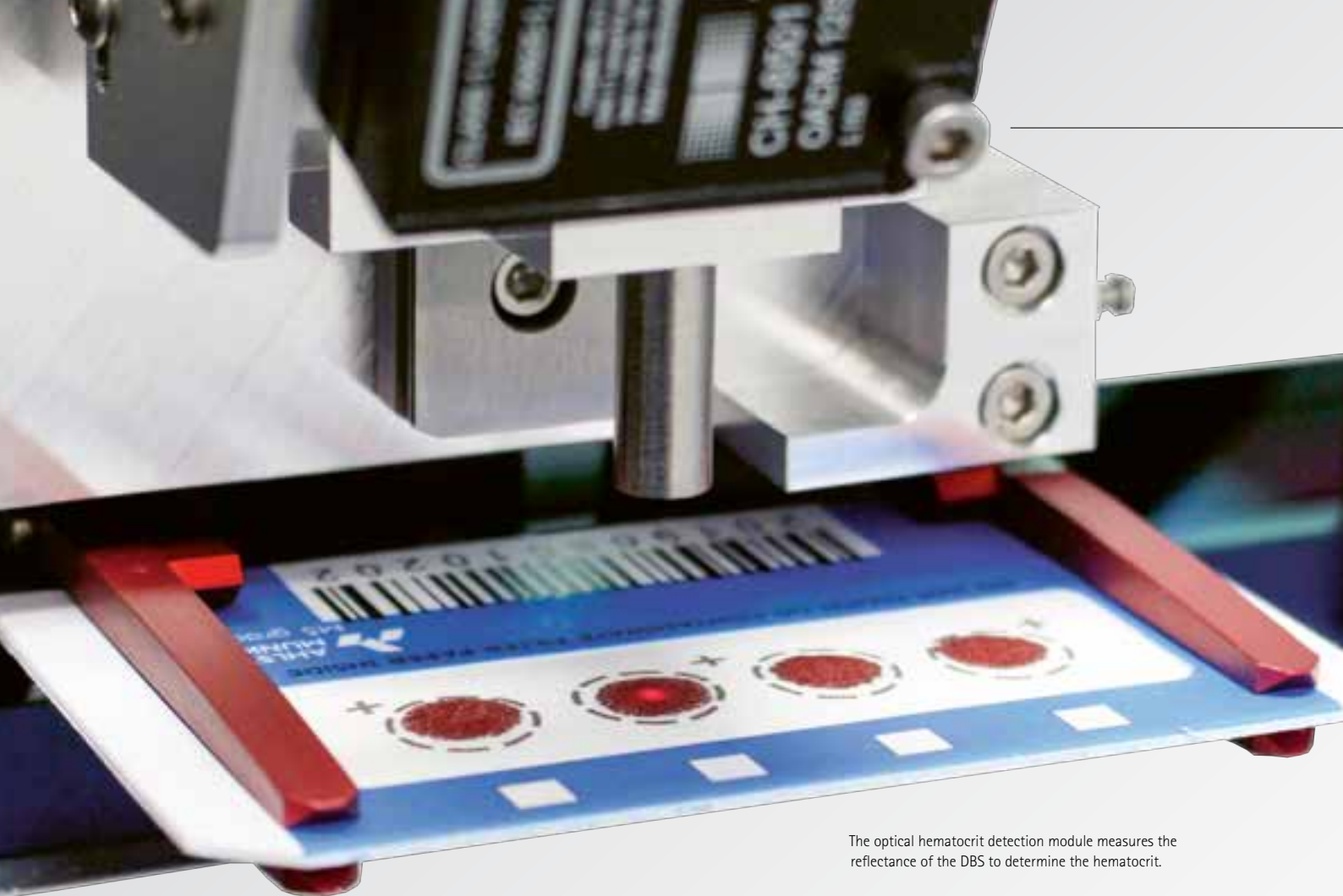

The optical hematocrit detection module measures the reflectance of the DBS to determine the hematocrit.

Fully automated and hematocrit corrected phosphatidylethanol analysis

The Swiss-based CAMAG DBS Laboratory in collaboration with the Institute of Forensic Medicine in Bern, Switzerland, has developed a novel approach for the fully automated analysis of the direct alcohol marker phosphatidylethanol (PEth) in dried blood spots (DBS). The use of a DBS autosampler with an embedded hematocrit (HCT) scanner combined with an LC-MS system permits analysis of large sample volumes and correcting for the red blood cell volume percentage, without any manual sample preparation.

With a total analysis duration of only 5 minutes per DBS sample, including photo documentation of the DBS card before and after the extraction, hematocrit measurement, and internal standard spray application, the developers believe that the novel fully automated workflow is quicker, easier and cheaper than current PEth testing routines. Manual steps such as cutting DBS, adding extraction solvent and internal standard, mixing and shaking, centrifugation, evaporation and reconstitution of the sample become obsolete. Furthermore, the use of DBS cards permits sending the specimen in an envelope to a centralized laboratory without cooling.

Dr Marc Luginbühl, principal scientist at the CAMAG DBS laboratory, says: "The novel workflow has been validated. In comparison to liquid blood extraction and manual DBS extraction it shows excellent reproducibility. Additionally, with the latest implementation of a HCT scanner to correct for the red blood cell volume percentage, we have made a crucial step forward. As PEth is mainly present within the red blood cell fraction, the sample's hematocrit should be taken into account when doing PEth analysis, as it can significantly influence the outcome. Using the instrumental setup presented here, this becomes accessible in a straightforward and fully automated way for the first time."



CONTACT

Shimadzu Europa GmbH
Albert-Hahn-Str. 6-10, 47269 Duisburg, Germany
phone: +49-203-76 87 0 · fax: +49-203-76 66 25
shimadzu@shimadzu.eu · www.shimadzu.eu

What is PEth analysis needed for?

Phosphatidylethanol is formed as abnormal phospholipids within the human body when ethanol is present. PEth itself is not a single molecule, but rather a group of molecules that differ from each other in their fatty acid chain composition. As PEth accumulates in the red blood cells, which prolongs its window of detection, it became popular as a direct alcohol biomarker. Thereby, PEth's strength lies in recognizing the drinking habits during the past two to four weeks, rather than the detection of a single drinking event with limited quantities of alcohol. PEth 16:0/18:1 and PEth 16:0/18:2 are the two most abundant PEth homologs in human blood and are often measured together. The concentration of PEth 16:0/18:1 is frequently used to classify alcohol consumption behavior based on two threshold concentrations: a lower threshold is used to distinguish between light or no alcohol consumption and is usually set at 20 ng/mL ($\sim 0.03 \mu\text{mol/L}$). An upper threshold is used to distinguish between substantial alcohol consumption and heavy alcohol consumption and is set at $\sim 200 \text{ ng/mL}$ ($\sim 0.3 \mu\text{mol/L}$). The analysis of PEth is applied in the follow-up of alcohol-impaired drivers, diagnosis and treatment of alcohol use disorders, newborn screening for fetal alcohol syndrome, organ transplantation and in the security environment. Compared to other direct or indirect alcohol markers (EtG, CDT, or GGT) PEth was found to have better sensitivity and specificity in various studies.

Fully automated PEth analysis

The combination of a CAMAG DBS autosampler with a Shimadzu 8050 LC-MS system permits a hyphenated fully automated DBS-LC-MS/MS workflow. Thereby, the DBS specimen is eluted onto a short trapping column (Polar RP, 20 mm), separated on a longer analytical column (C5, 50 mm), and subsequently detected using electrospray ionization tandem mass spectrometry. The use of a double-column system has the major advantage that a solid-phase extraction like purification of the target analytes is achieved, which reduces matrix effects, co-elution of disturbances and overall system contamination. In contrast to manual, passive extraction of DBS using a tube and a mixer at ambient pressure, the automated system performs an active extraction by constantly pumping fresh extraction solvent through the DBS. After the extraction of each DBS sample, the extraction cell of the autosampler is washed with a selection of three different wash solutions. By using an additional six-port valve installed on the Shimadzu LC-MS system, seamless switching between the CAMAG DBS autosampler and the standard vial autosampler is possible without reconnecting any capillaries.

Why use dried blood spots?

PEth showed limited stability in liquid blood unless stored at -80°C . It was observed that the use of dried blood microsamples increases the sample stability: using DBS, the post-sampling formation and degradation of PEth can be prevented and the stability of the samples is improved, as any enzyme activity is stopped during the DBS's drying process. Overall, the collection of DBS microsamples is easier, less invasive and cheaper than conventional whole blood sampling, as samples can be handled, shipped and stored more cost



Laboratory equipped with a DBS-MS 500 HCT and a Shimadzu 8060 LC-MS system

efficiently over a prolonged time. In addition, specimen collection can be done by untrained persons, including the study subjects themselves and in remote settings.

How does the DBS hematocrit measurement work?

"What we developed and implemented for PEth analysis", Marc explained, "is a way of obtaining the hematocrit from already dried samples in a fully automated fashion, thus making it possible to measure hundreds of DBS samples in a non-destructive way." The automated hematocrit detection is based on a patented reflectance measurement setup and is not influenced by humidity, temperature or the age of the DBS. During the measurement, a probe illuminates the DBS and measures its reflectance at a very specific wavelength. A built-in laser allows controlling and adjusting of the distance between the probe and the DBS. As the signal measured is proportional to the hematocrit of the sample, the red blood cell volume percentage can be calculated based on a pre-recorded calibration curve. Thereby, the HCT scanner allows normalizing for any known HCT related DBS effect such as the HCT area bias, the HCT recovery bias, or HCT related analyte properties. Furthermore, it is possible to normalize the analytical result to a selected HCT value. The system is ideally suited for the reliable, quantitative analysis of non-volumetric DBS samples.



PROFILE

Dr Marc Luginbühl is the principal scientist of the CAMAG DBS Laboratory, which develops automated dried blood spot solutions. His specific areas of expertise lie in the assessment and measurement of biomarkers using microsampling strategies with a passion for drug of abuse screening and alcohol biomarker analysis. With a PhD in Chemistry and Molecular Sciences, he is a member of The Society of Forensic Toxicologists (TIAFT) and the founder of The Society of Phosphatidylethanol Research (PEth-NET).

Immunoassays

Zybio – Q8 Pro Fluorescence Immunoassay Analyzer



Dimensions: 416 × 395 × 404 mm (w × d × h)
Sample throughput: 120 tests/h
Power consumption: 100-240 V~, 50/60 Hz, 150 VA

- Highlights:**
- Integrated reagent card scanning and discard module can reduce the size of the instrument and the failure rate
 - On-call detection with 25 independent channels greatly improves detection efficiency
 - Advanced time-resolved fluorescence immunoassay
 - Direct identification technology greatly improves detection sensitivity

Integrated Systems

Mindray – SAL 6000 Modular System



Sample throughput: Chemistry up to 1,200 tests/h (including ISE),
 Immunology up to 240 tests/h
No of channels: 68 (Chemistry) / 36 (Immunology)
Assays: 132

- Highlights:** The SAL 6000 is a high performance chemistry and immunology integrated system, combining BS-800 chemistry analyzer, CL-2000i immunology analyzer and the SPL 1000 sample process line. The system offers a large capacity of 300 samples with continuous loading by racks. It supports onboard sample pretreatment for HbA1c testing.

Mindray – SAL 9000 Modular System



Sample throughput: Chemistry up to 2,200 tests/h (including ISE),
 Immunology up to 480 tests/h
No of channels: 67 (Chemistry) / 36 (Immunology)
Assays: 132

- Highlights:** The SAL 9000 is a high performance chemistry and immunology integrated system, combining BS-2000 chemistry analyzer, CL-6000i immunology analyzer and the SPL 1000 sample process line. The system offers a large capacity of 300 sample positions and supports non-stop continuous sample loading. It offers a large capacity of 600 samples with continuous sample loading by racks, dedicated STAT channel, and sample tray direct loading and offloading.

Siemens Healthineers – Atellica Solution



- Highlights:** Atellica Solution immunoassay and clinical chemistry analyzers, powered by Atellica Integrated Automation, feature patented bidirectional magnetic sample transport technology, the flexibility to create over 300 customizable configurations, and a broad assay menu with proven detection technologies.
 Product availability will vary by country.

Integrated Systems

Siemens Healthineers – Dimension EXL 200 Integrated Chemistry System



Highlights: Dimension EXL 200 Integrated Chemistry System integrates chemistry and immunoassay testing in a compact system ideal for smaller-sized laboratories. Consolidate testing with a broad menu, including cardiac, thyroid, and automated-pretreatment immunosuppressive drug assays. Transition easily and correlate results between core and satellite labs using the partnership of the Atellica Solution and the Dimension EXL 200 Integrated Chemistry System.

Product availability varies by country.

Mass Spectrometry

Biomaneó – NeoSickle solution



Sample throughput: 200 samples/h
Number of parallel samples: 96 samples/h

Highlights: NeoSickle solution for screening of haemoglobinopathies including:

- Two Kits: NS540/NS96
 Suitable for analysis by MALDI-MS 8020 high-throughput analysis: 1000 samples/day
 Reliability, usability, fast and quality
- Neoplate: traceability, security of transport of DBS punches
 Neoscreening automated, accurate data interpretation software:
- eNeoSickle module:
 for MALDI-8020 data (Haemoglobinopathies)
- NeoAMAC module:
 for LC-MS/MS data (Metabolic diseases)

Shimadzu – LCMS-8060 NX (RUO)



Dimensions: 1180 × 540 × 610 mm (w × d × h)
Weight: 140 kg

Highlights: The LCMS-8060NX delivers high sensitivity and ultra fast analysis speed together with robustness and high flexibility. Developed on the base of the LCMS-8060, it incorporates a newly designed ion source IonFocus to boost ion transfer to the mass spectrometer and increase even more the robustness of the system for complex biological matrices in daily analysis. The system perfectly suits to high sensitivity applications like steroids, catecholamines, and metabolomics studies in clinical research.

Shimadzu – LCMS-8060 CL (IVD) / LCMS-8060 (RUO)



Dimensions: 1180 × 540 × 610 mm (w × d × h)
Weight: 140 kg

Highlights: The LCMS-8060 CL delivers the highest sensitivity and fastest analysis speed of any LCMS on the market today. A newly developed UF-Qarray boosts ion intensity but suppresses noise. By improving the ion sampling device, the ion guide, and vacuum efficiency, Shimadzu has achieved an unprecedented sensitivity in quantitative analysis by LC/MS/MS while keeping high robustness for daily analysis.

Mass Spectrometry

Shimadzu – LCMS-8050 CL (IVD) / LCMS-8050 (RUO)



Dimensions: 1180 × 540 × 610 mm (w × d × h)

Weight: 140 kg

Highlights: Triple Quadrupole Mass Spectrometry is the method of choice for quantification of trace-level analytes in complex samples for a variety of applications including clinical research, forensic, toxicology, pharmacokinetics. Combined with our world-leading UHPLC systems, and maintaining Shimadzu's proprietary ultrafast technologies (UFMS), which include high-speed MRM transitions, MS/MS acquisition, and ultra-high speed polarity switching, the LCMS-8050 can dramatically improve analytical throughput.

Shimadzu – LCMS-8045 CL (IVD) / LCMS-8045 (RUO)



Dimensions: 1180 × 540 × 610 mm (w × d × h)

Weight: 140 kg

Highlights: The LCMS-8045 offers the proven high sensitivity, high speed and robustness of Shimadzu's UFMS series to provide highly reliable data for applications that demand the sensitivity and speed of a mass spectrometer, such as for simultaneous analysis used in the clinical research field. Due to the heated-ESI probe and UFSweeper II collision cell, it offers the highest sensitivity in the middle-range class (UFsensitivity).

Shimadzu – CLAM-2030 CL (IVD) / CLAM-2030 (RUO)

Dimensions: 670 × 700 × 1190 mm (w × d × h)

Weight: 185 kg

Assays: Immunosuppressants, vitamin D, steroids, antiepileptics, antiarrhythmics drugs, amiodarone, drugs of abuse, anitdepressants, neuroleptics



Highlights: CLAM-2030 provides users seamless integration of automated sample preparation with LC-MS/MS to improve data quality, sample throughput, laboratory efficiency and safety. Simple workflows allow users to go from blood collection tubes to results without any additional sample handling. Each sample is processed successively in parallel, to optimize instrument usage. Easy to access software for management of reagents, calibration curves, control samples and maintenance ensure reliability and quality of results.

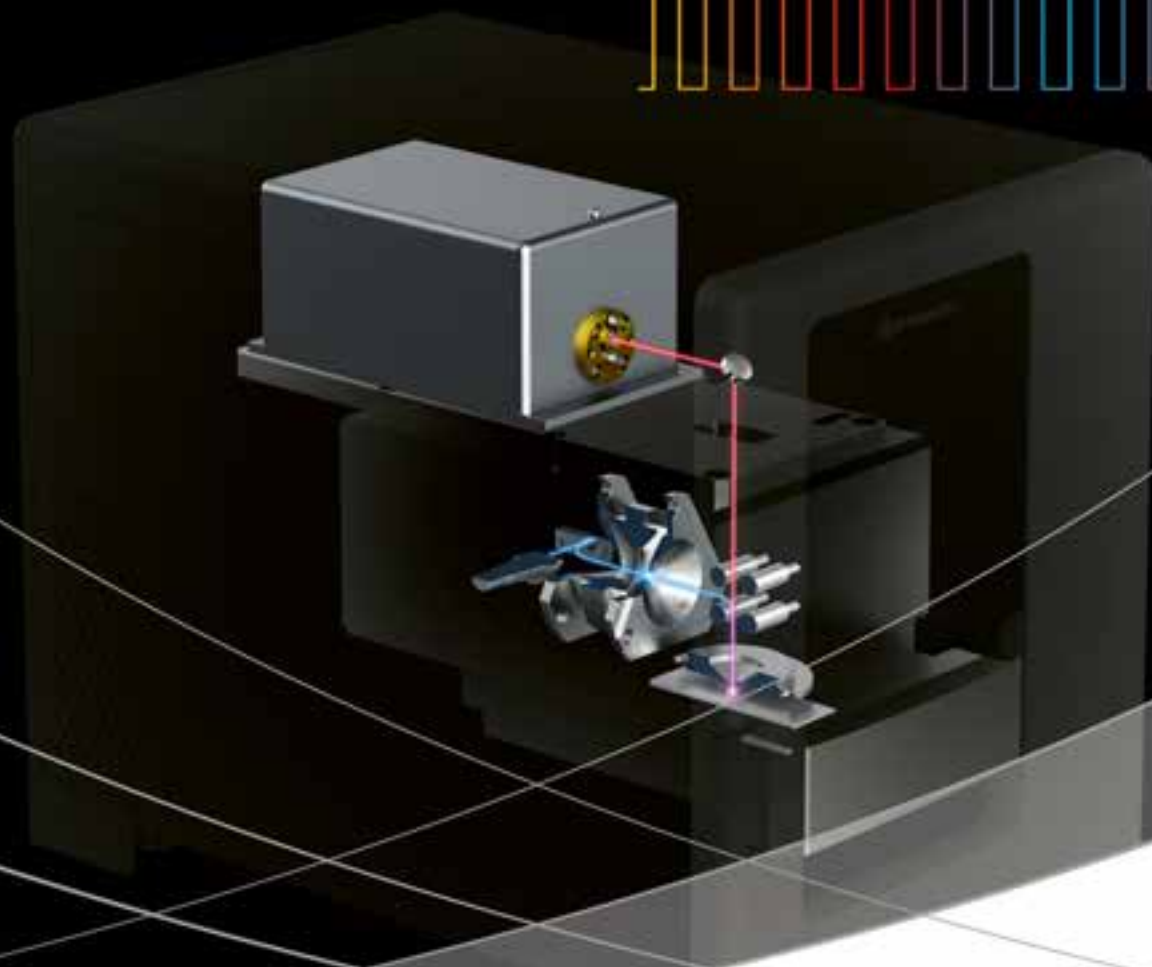

Entering the digital age in MS

Introducing the MALDImini-1 digital ion trap mass spectrometer

Shimadzu's first-of-its-kind MALDImini-1 digital ion trap mass spectrometer fits in a space the size of a piece of paper, allowing installation in places where mass spectrometers could not previously fit. It enables ion trapping up to 70,000 Da and the MS/MS and MS³ functionality of the digital ion trap allows researchers to carry out comprehensive structural analyses with ease.

- **Fast, simple setup allows for a more convenient workflow**
- **Software allows switching quickly and easily between MS, MS/MS and MS³ modes for seamless analysis**

- **Only device capable of MALDI-MSⁿ in this compact size**
- **Space-saving lightweight design fits anywhere**

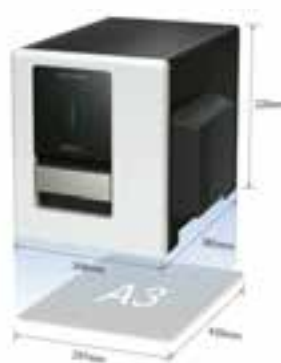

MALDImini-1



reddot winner 2021

Mass Spectrometry

Shimadzu – nSMOL Antibody BA Kit



Assays: 100

Highlights: nSMOL is a proprietary, innovative technique from Shimadzu, enabling selective proteolysis of the Fab region of monoclonal antibodies. The nSMOL Antibody BA Kit is a ready-to-use reagent kit for collecting monoclonal antibodies from blood or other biological samples using immunoglobulin collection resin, and then performing selective proteolysis of the Fab region of these antibodies via FG beads Trypsin DART. Fab-derived peptide fragments produced by limited digestion can then be quantified via LC-MS/MS.

Electrophoresis / Chromatography

Shimadzu – HPLC/UHPLC (RUO or CE-IVD)



Highlights: Shimadzu is offering a wide range of solutions in liquid chromatography starting from standard HPLC systems to high end UHPLC systems including compact configurations. Available with several options for columns switching, pre-concentration, online SPE, etc, the systems are also well recognized for coupling with highly sensitive detectors like fluorescence, radio-activity, electrochemical, or mass spectrometry. To increase throughput with mass spectrometers, Shimadzu offers the Nexera-MX configuration.

Plasma Protein Testing

Siemens Healthineers – BN II System



Sample throughput: Effective: approx. 130 tests/h
depending on the assay mix
Nominal: 225 tests/h

Assays: More than 60 programmed assay protocols

Weight: Analyzer: 150 kg

Highlights: The BN II System is an easy-to-use, reliable nephelometric analyzer that offers a broad range of protein assays.

- Connectivity options to Apto Automation and FlexLab Automation solutions
- Fully automated assay processing: from reading of sample tube bar codes to reporting of results
- Routine and specialty assay consolidation
- Innovative markers including monoclonal kappa and lambda free light chains (FLC), cystatin C, beta-trace protein (BTP), and carbohydrate-deficient transferrin (CDT)

Siemens Healthineers – Atellica NEPH 630 System

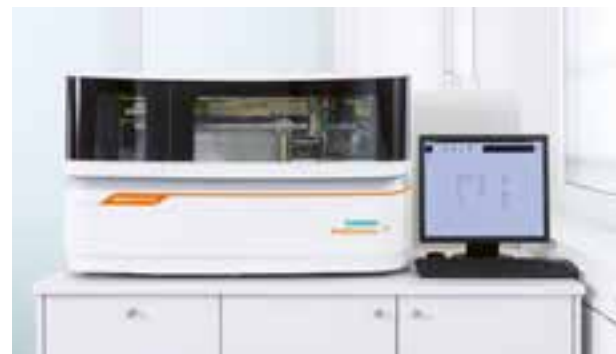

Sample throughput: Effective: approx. 65 tests/h
depending on the assay mix
Nominal: 100 tests/h

Assays: More than 60 programmed assay protocols

Weight: Analyzer: 115 kg

Highlights: The Atellica NEPH 630 System is a mid-volume dedicated nephelometric analyzer that simplifies lab operations in specialty protein testing.

- Innovative assays including free light chains (FLC), carbohydrate-deficient transferrin (CDT), and beta-trace protein (BTP)
- Sophisticated antigen-excess pre-reaction protocols provide more accurate results and fewer repeats

Not available for sale in the US. Product availability may vary from country to country and is subject to varying regulatory requirements

Drug Testing

Siemens Healthineers – Viva-ProE System

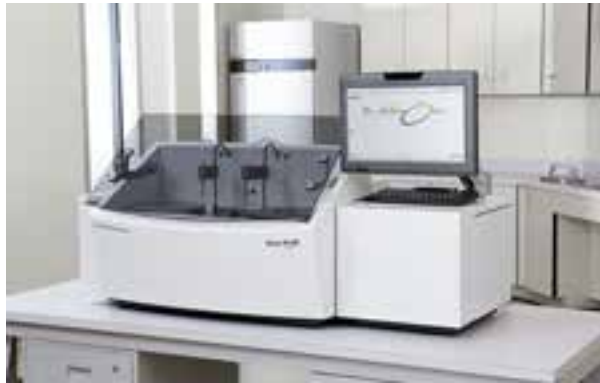

Sample throughput: up to 133 EMIT tests per hour with two reagents; up to 65 EMIT tests per hour with three reagents
Weight: approx. 93 kg / 205 lbs (excl. monitor arm and panel PC)

Highlights: A flexible approach to dedicated drug-testing analysis, the Viva-ProE System provides greater ease of use, workstation efficiency, and a full drug-testing menu, all in one powerful benchtop system that is supported by unrivaled Syva experts. The system offers peltier cooling for efficient reagent use, can run up to 133 Emit tests per hour and 12 Emit assays simultaneously; 120 tests can be programmed with 10 open test channels. Results available within 10 minutes of processing.

Urine Screening

Dirui – FUS-1000 Urinalysis Hybrid



Dimensions: 520 × 702 × 556 mm (d × w × h)
Principle: Flow-type micro-imaging technology (formed element detection)
Sample throughput: 60 tests/h
Sample capacity: 50

Highlights:

- Support cap-piercing function
- Reviewable images
- A hybrid urinalysis analyzer which can perform chemical, physical and formed element test

Sarstedt – Urine V-Monovette, Monovette, tubes & containers



Highlights:

- The diverse, user-friendly products for urine collection offer pre-analytical and post-analytical solutions thanks to their simple, hygienic use. Our range of conical urine tubes is ideally suited for sediment recovery and subsequent microscopic analysis.
- Urine-Monovette: For hygienic and needle-free urine collection, transport and analysis.
- V-Monovette Urine: For enclosed urine transfer. Optimal hygienic and convenient handling.

Urine Microbiology

Greiner – Vacuette Urine CCM Tube



Highlights:

- For use in microbiology testing
- Stabilizes sample for up to 48 hours at room temperature
- Easily soluble powder additive
- Immediate stabilization of sample after gentle mixing

Saliva Collection

Greiner – Saliva Collection System



- Highlights:**
- No time delay caused by dry mouth
 - Simple reproducible saliva collection
 - Internal standard (tartrazine) enables donor-specific quantification
 - Sufficient sample volume for sample splitting
 - For professional use and self-collection

Rapid Testing

Sarstedt – Blood gas Monovette and capillaries



- Highlights:**
- Blood gas collection systems for arterial, venous and capillary sampling with the smallest sample volumes and Ca²⁺ balanced heparin.
 - The Ca²⁺ balanced heparin in spray-dosed droplet form enables rapid and optimal mixing of blood and anticoagulants.
- The Blood gas Monovette is available in 1 and 2 ml options and has been designed for venous and arterial blood collection. The blood gas capillaries offer a nominal volume range of 100 – 175 µl.

CSF and Alzheimer's Disease Diagnostics

Sarstedt – CSF false-bottom tube



- Highlights:**
- Excellent recovery thanks to low-binding properties
 - Routine-use primary container for sample collection and automated analytics
 - Patient-friendly sample volume of 2.5 ml
 - Cost-effective alternative to PET scan
 - Reliable pre-analytics for optimum sample integrity

The new CSF false-bottom tube (art. no.: 63.614.625) meets the requirements for reliable pre-analytics in Alzheimer's disease diagnostics.

The tube combines optimum low binding properties with standardized 75 x 13 mm dimensions for ideal handling and processing of this very special sample material.

Thanks to the special low binding property, the high-quality material prevents the binding of Alzheimer's disease biomarkers and allows for maximum recovery in the sample material for reliable dementia diagnostics.

The CSF false-bottom tube is recommended as standard in the pre-analytical consensus protocol and has already been validated for the new immunoassay generation from Roche.

Research Use Only

Shimadzu – MALDImini-1

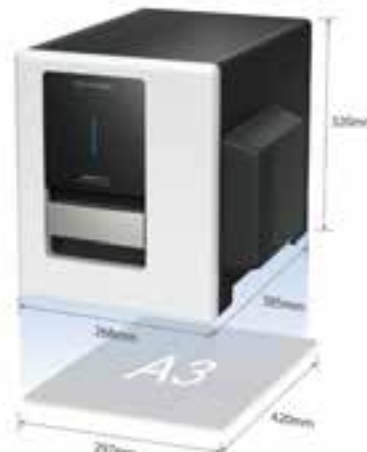

- Dimensions:** 309 x 385 x 320 mm (w x d x h)
Weight: 25 kg

- Highlights:** With its simple configuration and compact size, it is possible to install the MALDImini-1 in places where mass analysis devices could not previously be used. Through ingenious engineering and innovation its footprint has been reduced to the size of a piece of paper. The MALDImini-1, with its MS3 capabilities, can be used in research facilities, educational organizations and private structures involved in biomedical science or which carry out research on the structure of glycans.

Hematology

Blood Cell Counter
Integrated Hematology
Microscopy
Hemostaseology
Hemoglobin / HPLC



DIRUI



Lifotronic

mindray



Chronic liver disease

A looming pandemic and the need for physician partnerships to leverage non-invasive testing

By Dr. Katherine Soreng, Global Director of Clinical Education, Siemens Healthineers



PROFILE

Dr Katherine Soreng has her PhD in Immunology and Molecular Pathogenesis from Emory University in Atlanta, and completed her two-year post-doctoral fellowship at the National Centers for Infectious Disease at the Centers for Disease Control and Prevention (CDC) in the U.S. Today, she serves as a clinical and scientific expert for Siemens Healthineers and leads clinical support for the company's Laboratory Diagnostics business area in both infectious disease and liver fibrosis.

Even as we battle one pandemic (COVID-19), we sit on the cusp of another. Europe has one of the highest burdens of chronic liver disease (CLD) in the world, driven largely by alcohol overconsumption, viral hepatitis, and obesity.¹ Furthermore, non-alcoholic fatty liver disease (NAFLD) is increasingly common and is a significant contributor to CLD – especially in people with diabetes, where its prevalence is 68%.² Moreover, the number of adults with diabetes continues to climb.

NAFLD encompasses a spectrum of disease – from simple steatosis (fat buildup in the liver) to inflammatory damage associated with non-alcoholic steatohepatitis (NASH), fibrosis, cirrhosis, and liver-related events (LREs). NASH develops in about 20% of people with NAFLD and elevates risk, but data clearly implicates advancing fibrosis – which can occur in both NAFLD and NASH – as the primary predictor of LREs. Assessing at-risk patients for progressive fibrosis, therefore, is essential if we are to improve earlier management and outcomes.

"We are now seeing the burden from chronic liver disease that really started decades ago," explains Prof. Manuel Romero-Gómez of Virgen del Rocío University Hospital in Seville. "NAFLD-related chronic liver disease is becoming pandemic – and without implementing measures for appropriate referrals, the patient load could quickly become unmanageable."

Earlier recognition is key

CLD typically evolves over many years and often is clinically silent until there is an acute deterioration in liver function. According to Prof. Romero-Gómez, "We must increase identification of those patients with advancing fibrosis before they present with an LRE because that is when intervention measures are more effective." In short, diagnoses tend to occur late, when only limited therapeutic options are available.³ Interceding before acute deterioration may slow – and even reverse – disease progression.

Without a substantial focus on earlier detection in at-risk populations, the coming decade will likely produce a colossal burden of advanced NAFLD-associated CLD. It is imperative that physicians assess their patients for NAFLD and advancing disease – especially in the primary care setting, where timely referral to hepatologists and other appropriate specialists may improve outcomes.

Fibrosis drives disease progression.

Liver fibrosis is active tissue scarring caused by the deposition of extracellular matrix proteins, including collagen, and occurs in most types of CLD. Although repair mechanisms within the liver can drive significant reversal of damage, these mechanisms also can become overwhelmed by advancing fibrosis.

Biopsy has been used for decades to detect liver fibrosis but has drawbacks – including invasiveness, limited testing volume, and the potential for flaws in diagnostic accuracy due to sampling issues and variation in observer interpretation. Non-invasive

testing (NIT) that uses biomarkers, or imaging, as an alternative diagnostic tool for fibrosis assessment holds the potential for earlier detection – and for dramatically transforming CLD management – but it requires close coordination between physicians and specialties.

NITs that use blood-based biomarkers offer the greatest capacity for routinely assessing large numbers of patients for liver fibrosis. Easy-to-use diagnostic pathways that employ these types of NITs have been identified – and data shows that using them leads to a substantial increase in the detection of advanced fibrosis or cirrhosis, while also delivering a marked decrease in inappropriate referrals.⁴

Prof. Romero-Gómez explains why this is important: "Keep in mind that the average primary care physician is seeing 100 patients to detect two or three at high risk of advanced fibrosis. That is where NITs can transform patient management – by supporting identification of that subset of patients truly in need of referral."

Biomarkers fall into two categories – indirect markers that assess for evidence of damage or inflammation, such as FIB-4, and direct markers, which detect for evidence of active fibrosis.

- The best-studied of the direct biomarkers is the ELF Test – a fully automated algorithm-based blood test that assesses for three direct markers of active fibrosis. → Table 1.
- Notably, it requires only a single routine serum sample and produces a simple-to-interpret numeric score. → Figure 1.
- More than 15 years of studies document ELF's performance. NAFLD diagnostic pathways incorporating ELF have shown a substantial increase in detection as well as a decrease in inappropriate referrals. → Figure 2.

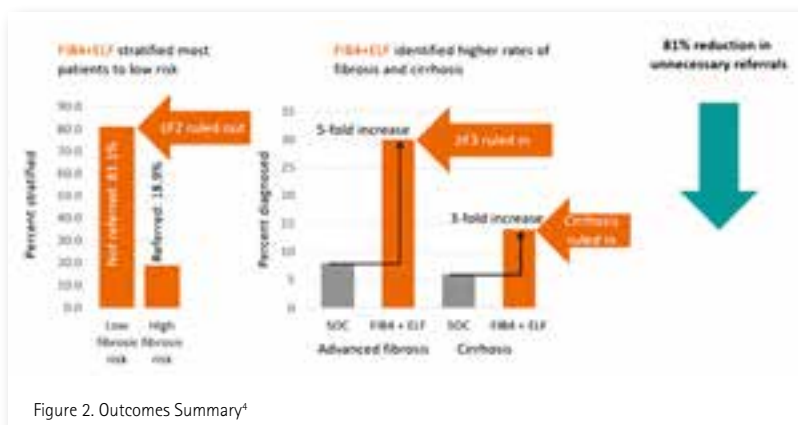

Figure 2. Outcomes Summary⁴

Unlike biopsy or imaging, which assess for existing damage, or indirect markers, which reflect damage or inflammation, ELF biomarkers are associated with active fibrosis, supporting both diagnostic and prognostic utilities.

"NITs are providing valuable tools and associated guidelines for the detection of advanced fibrosis and cirrhosis," says Prof. Romero-Gómez. "A simple blood test like ELF, or ELF in conjunction with a test like FIB-4, offers the greatest facility for assessing the high volume of at-risk patients presenting in primary care or related settings. As a hepatologist, I can be very confident that at-risk patients coming to me with a high ELF score benefit from the referral, whereas those with lower ELF scores can remain effectively managed in their current clinical setting."

A collaborative approach is imperative

All told, the clinical and economic burdens of NAFLD in Europe are particularly high and will likely increase as its incidence continues to rise. Earlier diagnosis and intervention hold the potential for reducing future healthcare – and human – costs. To be effective, routine testing for evidence of disease progression relies heavily on provider awareness and cross-specialty collaboration.

"Since most of our referrals come from primary care or specialties like GI or diabetology, it is essential that we partner in a peer-to-peer fashion to optimize a diagnostic referral pathway," emphasizes Prof. Romero-Gómez, who advocates for a close, coordinated partnership between hepatologists and those clinicians most likely to initially encounter patients at-risk for CLD. "NITs like ELF will be key to facilitating that partnership."

Analyte	Role in liver fibrosis (ECM: Extracellular Matrix)
Hyaluronic acid (HA)	Essential component of the ECM synthesized primarily by activated hepatic stellate cells
Procollagen (I) amino terminal peptide (PIIINP)	Derived from collagen type I (a common form of collagen found in the liver) and a direct indicator of collagen synthesis and ECM deposition
Tissue inhibitor of metalloproteinase 1 (TIMP-1)	Inhibits matrix metalloproteinases involved in fibrinolysis and repair. Often upregulated during hepatic fibrosis

Table 1. ELF Test Markers

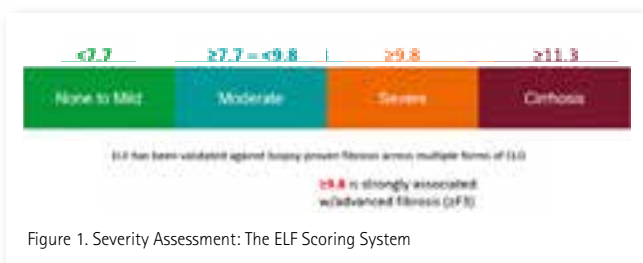

Figure 1. Severity Assessment: The ELF Scoring System



CONTACT

Siemens Healthineers
Laboratory Diagnostics
511 Benedict Avenue · 10591 Tarrytown, NY, USA
phone: +1 914 631 8000 ·
www.siemens-healthineers.com/laboratory-diagnostics

References

- 1 Pimpin L, Cortez-Pinto H, Negro F, et al. Burden of liver disease in Europe: Epidemiology and analysis of risk factors to identify prevention policies. *Journal of Hepatology*. 2018;69(3):718-735. doi:10.1016/j.jhep.2018.05.011
- 2 Younossi ZM, Golabi P, de Avila L, et al. The Global Epidemiology of NAFLD and Nash in patients with type 2 diabetes: A systematic review and meta-analysis. *Journal of Hepatology*. 2019;71(4):793-801. doi:10.1016/j.jhep.2019.06.021
- 3 Wong RJ, Kachru N, Martinez DJ, Moynihan M, Ozbay AB, Gordon SC. Real-world comorbidity burden, health care utilization, and costs of nonalcoholic steatohepatitis patients with advanced liver diseases. *Journal of Clinical Gastroenterology*. 2020; Publish Ahead of Print. doi:10.1097/mcg.0000000000001409
- 4 Srivastava A, Gailer R, Tanwar S, Trembling P, Parkes J, Rodger A, Suri D, Thorburn D, Sennett K, Morgan S, Tsochatzis EA, Rosenberg W. Prospective evaluation of a primary care referral pathway for patients with non-alcoholic fatty liver disease. *J Hepatol*. 2019 Aug;71(2):371-378. doi: 10.1016/j.jhep.2019.03.033. Epub 2019 Apr 6. PMID: 30965069

Blood Cell Counter

Beckman Coulter – DxH 690T

Dimensions:

755.7 × 1740 × 828 mm (w × h × d)

Weight:

254 kg

Sample throughput:

up to 100 samples/h

Power consumption:

520 W*



Highlights:

The DxH 690T offers all the benefits of Beckman Coulter's flagship DxH 900 hematology analyzer to mid-size labs, including an industry leading 93% first pass yield and the Early Sepsis Indicator. The only FDA-cleared hematology biomarker for sepsis, the ESId measures monocyte distribution width to support early detection of life-threatening sepsis for patients in the ED.

- Automate QC processes to complete tasks with 75% fewer steps, and 40% faster software response time, than previous generation mid-volume hematology analyzers
- Apply extensive sample-specific rule-writing capabilities to automate analysis and standardize SOP sample handling – without the need for middleware

Beckman Coulter – Early Sepsis Indicator



Highlights:

A first-of-its-kind, hematology-based cellular biomarker, the FDA cleared Early Sepsis Indicator is designed to help emergency department physicians identify patients with sepsis or at risk of developing sepsis within 12 hours of ED presentation.

- Results are automatically reported as part of a routine complete blood count (CBC) with differential for adult emergency department patients
- Combined with clinical signs and symptoms and WBC results, the Early Sepsis Indicator can inform critical decision making in adults in the emergency care setting

Dirui – BF-7200Plus Hematology System



Dimensions:

835 × 620 × 770 mm (d × w × h)

Weight:

86 kg

Sample throughput:

CBC+DIFF: 120 tests/h (one module)

Parameters:

37 (including 7 RET parameters)

Highlights:

- Nucleic acid fluorescence staining integrated with semiconductor laser flow cytometry
- Maximum four modules together
- Five sample analysis modes and five test modes
- Automatic recheck function
- Low value WBC detection function

Greiner – Vacuette EDTA Tube



Highlights:

- Vacuette K2E K2EDTA tubes and K3E K3EDTA tubes are used for testing whole blood in haematology.
- Evacuated tubes for a clearly defined quantity of blood sample material
- Nominal volume between 2 and 9 ml according to the application
- Made out of virtually unbreakable PET plastic
- Selected tubes are available as premium tubes with screw thread for a safe sample transfer and easy opening. Several premium tubes can also be ordered with transparent labels.
- The colour coded caps fit the international standard according to ISO 6710.

Blood Cell Counter

Lifotronic – Auto 3-part Hematology Analyzer AC 310



Dimensions: 411 × 315 × 416 mm (h × w × d)
Weight: 26 kg
Sample throughput: 60 tests/h
Display: 10.4 inches touch screen

- Highlights:**
- Accurate measurement for low value PLT
 - Low running cost
 - One touch to start testing, one click to remove error, friendly operation menus
 - Large data memory: up to 100,000 results (Including histograms and patient information)
 - No printer limitation
 - Compact size
 - Automatic shutdown and maintenance

Lifotronic – Auto 5-part Hematology Analyzer AC 610 & AC 610

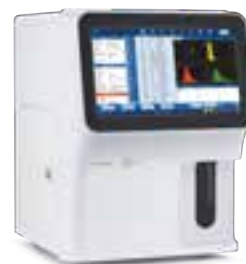

Dimensions: 517 × 375 × 480 mm (h × w × d)
Weight: 36 kg
Sample throughput: 60 tests/h
Display: 14 inches touch screen

- Highlights:**
- Cyanide free reagent for HGB test
 - Compact design with reagents on board, save the valuable bench space of small labs.
 - The first innovative analyzer combined the optical method of BASO (BASO-O) and impedance method of BASO (BASO-I)
 - Premium large touch screen
 - Smart-flow fluidic patent technology
 - Accurate measurement for low value PLT
 - Low running cost
 - No printer limitation
 - The only hematology analyzer with auto shut down function

MC-80

Automated Digital Cell Morphology Analyzer

Mindray's revolutionary MC-80 Automated Digital Cell Morphology Analyzer provides more clarity, more intelligence and more productivity for morphological analysis. It takes digital morphology analysis to the next level, delivering clearer images which are able to capture abnormalities in more detail. With advanced algorithms, the analyzer enables better identification of different cells with high throughput, resulting in greater productivity.

Connecting MC-80 with the CAL 8000 Cellular Analysis Line, Mindray now can provide a total solution for hematology analysis, assisting pathologists in quicker and more accurate diagnoses.

mindray



Blood Cell Counter

Mindray – BC-6800Plus Auto Hematology Analyzer



Sample throughput: CBC+DIFF 200 t/h, RET 120 t/h, BF 40 t/h

Highlights: BC-6800Plus is currently the fastest standalone hematology analyzer in the world, which can process 200 CBC+DIFF samples/h and 120 RET samples/h. Notably, the ERP channel can provide more research parameters such as MCHr and HDW, which can help early diagnosis of various types of anemia.

Mindray – BC-6200/6000 Auto Hematology Analyzer



Sample throughput: up to 110 t/h

Highlights:

- Unique SF Cube 3D cellular analysis technology for WBC 6-part diff count including IMG
- NRBC in every CBC+DIFF result
- Automatic rerun & reflex in case of abnormal results
- BC-6200 with RET channel can provide optional Reticulocytes and PLT-O parameters and perform automatic 8-times PLT-O counting for thrombocytopenia samples.

Sarstedt – S-Monovette ThromboExact – Pseudothrombocytopenia



Highlights: The S-Monovette ThromboExact has been developed especially for anticoagulant-induced pseudothrombocytopenia. Generally, pseudothrombocytopenia is caused by thrombocyte aggregation. Early detection avoids the consequences of a thrombocytopenia misdiagnosis.

This blood collection tube is validated internally by Sarstedt and externally at the University Hospital Rostock, Germany.

Sarstedt – Microvette APT – for routine capillary blood analysis



Highlights:

- Capillary blood collection system specially developed for automated processing in blood count analysis systems
- Greater flexibility thanks to two collection techniques – precise filling volume with end-to-end capillary (250 µl) and entire collection rim (250 – 500 µl) for optimum mixing with a K2 EDTA preparation
- Meets all the important processing requirements for a primary container and has a leak-proof cap with pierceable membrane for safe transportation and shipping
- Improves the turn-around time in capillary blood analysis and reduces the need for repeated blood collection
- Available in ISO and EU colour code



Taking morphology analysis to the next level

Mindray's new automated digital cell morphology analyzer MC-80

Mindray has launched the new MC-80 Automated Digital Cell Morphology Analyzer, a revolutionary cell morphology system that provides more clarity, more intelligence and more productivity for morphological analysis. Combining MC-80, Mindray's hematology solution will revolutionize the high-end hematology segment.

Morphological review of blood cells is a crucial procedure following hematology analysis. Most laboratories need to re-examine more than 30 percent of their blood samples, but find traditional microscopic review labor-intensive and time-consuming. Automated digital cell morphology analyzers are now available on the market, but providing clear and accurate cell images comparable to the microscope remains a fundamental challenge.

Mindray's new MC-80 is taking digital morphology analysis to the next level, delivering clearer images which are able to capture abnormalities in more detail. With advanced algorithms, the analyzer enables better identification of different cells with high throughput, resulting in greater productivity.

"We have spent eight years developing and optimizing the product by collaborating with over 200 top hospitals worldwide.

Meanwhile, we have applied for over 100 patents and solved many problems, some of which had been considered insurmountable in automated digital cell morphology analysis," commented Huan Qi, Director of Clinical Research, Medical Affairs; and Director of Upstream Marketing, IVD, Mindray.

The MC-80 provides more in morphology

More Clarity: Equipped with advanced multi-layer fusion technology, the MC-80 reproduces the pathological features of cells with clear and authentic images, which helps pathologists to detect abnormal cells more easily and make a quicker diagnosis.

More Intelligence: The MC-80 facilitates a smart process and less manual intervention by analyzing the smear in an optimal mode according to the results from hematology analyzers. Its advanced algorithms offer reliable cell pre-classification and pre-characterization, and the high-speed FLY-MODE ensures fast and accurate PLT clump identification.

More Productivity: With the remote review function, pathologists are able to review results from multiple locations. The high throughput of 60 samples per hour helps shorten the turnaround time, especially for large-sized laboratories. This greatly enhances diagnostic efficiency and ensures a faster delivery of results to patients.

Mindray is committed to providing high quality, reliable IVD solutions to empower trust, delivering accurate results while meeting laboratories' demands on efficiency worldwide.



CONTACT

SHENZHEN MINDRAY

Bio-Medical Electronics Co., LTD.

Mindray Building, Keji 12th Road South

High-tech Industrial Park, Nanshan

518057 Shenzhen, China

intl-marcom@mindray.com · www.mindray.com

Blood Cell Counter

Siemens Healthineers – Advia 360, 560, and 560 AL Hematology Systems



Dimensions: 360 × 316 × 492 mm (h × w × d)
520 × 410 × 490 mm (h × w × d)

Sample throughput: approx. 60 tests/h

Parameters: 22–26 parameters*
3- or 5-part white cell differential

Highlights: The ADVIA 360, 560, and 560 AL Hematology Systems provide laboratories with intuitive, easy-to-use, and scalable hematology solutions designed to offer the right fit for every lab. Each system delivers fast, reliable, and accurate CBC and white cell differential testing with the performance and adaptability that low- and mid-volume labs need. The optional autoloader on the ADVIA 560 AL System streamlines automatic sampling for even greater workflow efficiency.

*Not all parameters are available in the U.S.

Siemens Healthineers – Advia 2120i Hematology System



Dimensions: 860 × 1410 × 680 mm (h × w × d)

Sample throughput: up to 120 samples/h

Parameters: CBC incl. NRBC, 6-part white cell differential, reticulocytes, body fluids, and comprehensive morphology results

Highlights: The ADVIA 2120i Hematology System with Autoslide streamlines workflow by eliminating the majority of manual steps commonly performed to maximize productivity. Its unique testing methodology optimizes results while offering the simplicity and flexibility you need for easy integration into your lab. With connectivity to Aptio Automation, it supports accurate, fast, sample processing with fully customizable, user-defined features.

Zybio – Z3CRP Hematology Analyzer



Dimensions: 300 × 400 × 410 mm (w × d × h)

Weight: 20 kg

Sample throughput: up to 70 samples/h for CBC mode;
60 samples/h for CRP mode

Power consumption: <200 W

Highlights:

- Microsample volume for 10 µl whole blood
- 60-sec CRP result, only 1 drop venous blood via turbidimetry method
- One tube for blood test with 23 parameters including 2 CRP parameters
- Only 2 reagents for blood counting test and 2 reagents for CRP

Zybio – Z5 Hematology Analyzer



Dimensions: 230 × 435 × 435 mm (w × d × h)

Weight: 25 kg

Sample throughput: up to 60 samples/h for WBC 5-differentiation

Power consumption: <200 W

Highlights:

- Advanced tri-angle laser scattering and flow cytometry technology
- 29 parameters, 5 scatter grams and 3 histograms within 1 min
- Microsample volume for 18 µl venous/capillary whole blood
- Only 3 reagents (1 diluent, 2 lyses) for routine test

Integrated Hematology

Beckman Coulter – DxH 900 Hematology Analyzer

Dimensions:

755.7 × 1740 × 828 mm (w × h × d)

Weight:

254 kg

Sample throughput:

up to 100 samples/h

Power consumption:

520 W

Highlights:

The DxH 900 hematology analyzer is ideal for mid- to high-volume clinical laboratories performing complete blood count and white blood cell differential tests while minimizing repeat testing, allowing you to deliver the right results the first time.

- Achieve superb RBC, PLT and WBC differentials through near native-state cellular characterization and precise flagging
- Optimized processes help your laboratory maximize staff time through fewer slide reviews, automated QC, and longer walkaway and system uptime
- Most reportable results per square meter with industry-leading 93 percent first-pass yield and a >40 percent smaller footprint than competitive instruments
- Exclusive Early Sepsis Indicator: a one-of-a-kind FDA cleared hematologic biomarker designed to help emergency department physicians identify sepsis sooner
- The analyzer features a variety of workcell configurations to match laboratory workload, with a mounted user interface, onboard power computer and wireless peripherals, eliminating the need for extra hardware, such as a cart.



Mindray – CAL 8000

Dimensions:

Depending on configuration

Weight:

Depending on configuration

Sample throughput:

CBC+DIFF: up to 800 samples/h

SC-120: up to 240 slides/h

MC-80: up to 120 slides/h



Highlights:

- Fully Integrated with the hematology analyzer, slide maker & stainer and digital cell morphology analyzer
- Flexible configuration with buffer module, start/stock yard and turn module
- Assure accurate results of abnormal cells with advanced detection technology SF Cube
- Maximum detection efficiency with the fastest standalone analyzer
- Digital cell morphology system MC-80
- Streamline laboratory workflow with automatic rerun and reflex measurement
- Less maintenance frequency and cost with stable detection system
- More productivity: up to 60 slides/hour
- More clarity: the images look more three-dimensional, sharper in color and clearer.
- More intelligent: automatically choose the optimal mode for pre-classification of cells with a higher efficiency

Microscopy

Olympus – SC180



- Highlights:**
- 18-megapixel camera with fast 4K Live image
 - Dedicated to precise sample documentation even at low magnifications
 - Assisted sample focusing and image noise cancellation

The high-resolution, 18-megapixel SC180 color camera reveals your sample's fine details and structures. The 18 million pixel count exploits the full optical resolution of the objectives, enabling you to make observations exclusively on-screen without using the eyepieces and fostering effective collaboration and audience engagement during full-screen presentations. With a fast 4K live image, the SC180 camera accelerates routine work, increases throughput in various applications through fast assisted focusing and noise cancellation, and makes the screen the new standard for documentation, evaluation, and discussion.

Olympus – BX53LED



- Highlights:**
- Dedicated LED light source for microscopy (Olympus True Color LED)
 - Ergonomic design for intensive daily usage
 - Highly expandable frame to follow evolving application needs

The BX53 microscope's ergonomic design helps you stay comfortable during extended periods of use while the intuitive control layout enables fast, efficient observation and imaging. Optimized for laboratory applications, Olympus exclusive True Color LED illumination has a high luminosity and color rendering index so you can see samples in real-to-life colors avoiding color casts of generic LED light sources.

Hemostaseology

Greiner – Vacuette Coagulation Tube



- Highlights:**
- With safety twist cap for an easy manual opening as well as automated opening using decapping instruments
 - Correct mixing ratio of venous blood a sodium citrate is ensured during blood collection, so that the tube contains one part sodium citrate solution to nine parts blood
 - Double-walled technology: the inner tube is made out of polypropylene (PP) and prevents the citrate solution from evaporating; the outer tube is made of polyethylene terephthalate (PET) and ensures a long shelf-life for the vacuum

Siemens Healthineers – Sysmex CN-3000 and CN-6000 Systems*



- Sample throughput:** PT and APTT: 215 (CN-3000) / 400 (CN-6000) (per hour, simultaneous analysis)
- Dimensions:** Main unit: 720 × 906 × 1350 mm (w × d × h)
Opt. Sampler: 330 × 1030 × 830 mm (w × d × h)
- Weight:** Main unit: 230 kg / Optional sampler: 81 kg

- Highlights:**
- The Sysmex CN Systems* combine speed, flexibility, and intelligence with a small footprint to accelerate hemostasis workflows
 - High throughput in a small footprint for enhanced productivity
 - Flexible, modular connectivity options for automated testing in mid- to high-volume labs
 - Onboard predictive calculation of reagent use for fewer interruptions
 - Cutting-edge sample management and automatic gain switching for improved pre-analytical handling

* Not available for sale in the U.S. The products/features mentioned here are not commercially available in all countries and are subject to local regulations. Their future availability cannot be guaranteed.

Hemostatology

Siemens Healthineers – Atellica COAG 360 System



Sample throughput: PT and APTT: 350 (simultaneous analysis)
Dimensions: 1858 × 1042 × 1415 mm (w × h × d),
 without LAS connection
 2156 × 1042 × 1415 mm (w × h × d),
 with LAS connection
Weight: 600 kg (without LAS connection)
 617 kg (with LAS connection)

Highlights: The Atellica COAG 360 System* offers high-volume specialty hemostasis labs a transformative array of capabilities to streamline and unify hemostasis testing

- Five methodologies—clotting, chromogenic, immunologic, platelet aggregation and high-sensitivity immunoassay (LOCI) testing
- Primary-tube sample-volume checks, advanced assay-specific sample quality checks for hemolysis, icterus and lipemia (HIL) interference.
- Intelligent reagent and consumable management

*Not available for sale in the US

Siemens Healthineers – Sysmex CS-5100 System



Dimensions: approx. 1280 × 1,576 × 1150 mm (h × w × d)
Sample throughput approx. 400 simultaneous PT/APTT tests/h
Weight: approx. 362 kg

Highlights: The Sysmex CS-5100 System offers high-volume and multisite labs smartly designed PSI technology and automation connectivity for streamlined workflow and high-quality test results on the first run. Simultaneous, multiwavelength PSI technology helps labs to identify and manage unsuitable test specimens prior to analysis. The Sysmex CS-5100 System offers an expansive test menu of routine and specialty hemostasis assays (including several INNOVANCE assays).

Siemens Healthineers – Sysmex CS-2500 System



Dimensions: approx. 685 × 1113 × 895 mm (h × w × d)
Sample throughput approx. 180 simultaneous PT/APTT tests/h
Weight: approx. 140 kg

Highlights: The Sysmex CS-2500 System offers mid-volume and multisite hemostasis labs smartly designed technologies for improved efficiency, exceptional accuracy, and reliable first-run results. Equipped with next-generation PSI technologies, the system takes hemostasis testing to the next level. The Sysmex CS-2500 System offers an expansive test menu of routine and specialty hemostasis assays (including several INNOVANCE assays), all on a single instrument.

Siemens Healthineers – Sysmex CA-600 Systems



Dimensions: approx. 490 × 566 × 490 mm (h × w × d)
Sample throughput: approx. 60 PT tests/h
Weight: approx. 43 kg

Highlights: The Sysmex CA-600 Systems – with the smallest footprint in their class – are built on a history of proven reliability and provide scalable options for routine and specialty* coagulation testing.

- Features clotting, chromogenic*, and immunologic* measurements with true random access
- Enables critical tests to be processed at any time via STAT sample processing
- Offers the most frequently requested routine and specialty tests, including INNOVANCE D-Dimer*

*Sysmex CA-660 System only.

Hemostaseology

Teco – Coatron X



Dimensions: 230 × 140 × 90 mm (w × h × d)
Power Consumption: 110 – 240 Vac, 50 – 60 Hz / 5 Vdc, 3.3 A
Number Of Channels: 1 – 4

- Highlights:**
- Highest optical resolution, enlarged optic range, smallest sample and reagent volume 0,1 mOD – 3,500 mOD, just with 75 µL sample and reagent volume
 - Complete optical analysis
 - No further parts required, like balls, stirrers etc.
 - Adaptation of the light level
 - Automatic light level adjustment of the optic channels to each sample
 - Exclusion of disturbance
 - Stray light reduction, exact temperature control, all parameter are preset

Hemoglobin/HPLC

Lifotronic – H9 Hemoglobin Analyzer (HPLC)



Dimensions: 580 × 600 × 520 mm (h × w × d)
Weight: 50 kg
Sample loading capacity: 110 samples
HbA1c test time: 1.6 min/T

- Highlights:**
- HPLC methodology
 - Dual Mode: HbA1c mode & Thalassemia mode
 - HbA1c test: 1.6 mins/T; Thalassemia test: 6 min/T
 - System pressure: 4 – 12 MPa
 - CV ≤ 1.5%
 - Variants Detection
 - Automatic cap piercing
 - Fully automated start-up, maintenance and shutdown
 - NGSP and IFCC certified

Lifotronic – H8 Hemoglobin Analyzer (HPLC)



Dimensions: 600 × 360 × 540 mm (h × w × d)
Weight: 37 kg
Sample loading capacity: 10 samples
HbA1c test time: 2.2 min/T

- Highlights:**
- HPLC methodology
 - Dual Mode: HbA1c mode & Thalassemia mode
 - HbA1c test: 2.2 mins/T; Thalassemia test: 6 mins/T
 - System pressure: 4 – 12 MPa
 - CV ≤ 1.5%
 - Variants Detection
 - Automatic cap piercing
 - Fully automated start-up, maintenance and shutdown
 - NGSP and IFCC certified

Lifotronic – GH 900Plus Hemoglobin Analyzer (HPLC)



Dimensions: 450 × 360 × 540 mm (h × w × d)
Weight: 29 kg
Sample loading capacity: 5 samples
HbA1c test time: 130 sec/T

- Highlights:**
- HPLC methodology
 - HbA1c test: 130 sec/T
 - System pressure: 4 – 12 MPa
 - CV ≤ 1.5%
 - Anti-Variants Interference
 - NGSP and IFCC certified

Pathology

Scanner
Printer
Histology Equipment
Microscopy
Information Technology
Grossing Station
Coverslipper
Sample Collection

CliniSys
MIPS

DTM
medical

HAMAMATSU
PHOTON IS OUR BUSINESS

KABE
LABORTECHNIK

KUGEL
medical

MEDITE

OLYMPUS
Your Vision, Our Future

SARSTEDT

Scanner

Hamamatsu Photonics – NanoZoomer S360



Highlights: The NanoZoomer S360, our high end model, delivers exceptional scanning speed for clinical routine. It scans up to 360 slides automatically in one batch.

- Scanning speed:
20x mode (15 × 15 mm) approx. 30 s
40x mode (15 × 15 mm) approx. 30 s
- Capacity:
360 standard slides
- Check focus defects in scanned images at a glance
- Barcode reader:
1D barcode, 2D barcode (option)

Hamamatsu Photonics – NanoZoomer S210



Highlights: The NanoZoomer S210 is our standard model with a reasonable price and excellent cost performance. It has been well balanced among throughput, scanning speed, and price, and boasts the highest sales performance since its launch.

- Scanning speed:
20x mode (15 × 15 mm) approx. 60 s
40x mode (15 × 15 mm) approx. 150 s
- Capacity:
210 standard slides
- Barcode reader:
1D barcode, 2D barcode (option)

Hamamatsu Photonics – NanoZoomer S60



Highlights: The NanoZoomer S60 delivers the perfect combination of flexibility, excellent image quality and high speed scanning. It scans double size slides or standard size slides and supports brightfield and fluorescence imaging.

- Scanning speed:
20x mode (15 × 15 mm) approx. 60 s
40x mode (15 × 15 mm) approx. 150 s
- Capacity:
60 standard slides, 30 double size slides
- Fluorescence imaging module (option)
- Barcode reader:
1D barcode, 2D barcode (option)

DTM Medical – Primera Signature Cassette Printer



Highlights: The Signature Cassette Printer is designed for printing text, graphics or bar codes directly onto cassettes, helping to reduce the risk of misidentification of specimens. It is available as a stand-alone, manual printer (printer on the right side) or as a completely automated system consisting of a printer and a robotic picking system called Autoloader (system on the left side).

- On-demand or batch mode printing
- Black or colour printing
- Cost reduction by inventorying only white cassettes
- Chemical-resistant ink – ensures reliable identification of cassettes
- USB interface – ability to integrate with LIS
- Two years warranty
(After product registration within six months of purchase)

Printer

DTM Medical – Primera Signature Slide Printer



- Highlights:** The Signature Slide Printer can significantly increase the efficiency of labs while helping to reduce the risk of misidentification of specimens.
- On-demand, full-colour printing – prints only the number of slides needed
 - Prints directly onto slides – eliminates handwriting that is hard to read and labels that are hard to apply
 - Cost reduction by inventorying only white-frosted slides
 - Xylene-, alcohol-, heat- and chemical-resistant ink – ensures reliable identification of slides
 - PTSlide Software allows connection to LIS systems
 - Compact design
 - Two years warranty (After product registration within six months of purchase)

Histology Equipment

KABE Labortechnik – Consumables for pathology / histology



Highlights:

- Tissue embedding cassettes
- Five variants: standard, universal, biopsy, bionet and laser
 - Available in different colours
 - Without, with separate or with pre-attached hinged lid
 - Available pre-stacked – ready for use in cassette printers
 - High quality material is resistant to solvents, guarantees dimensional stability and offers good writing and printability
 - Comprehensive range of accessories
- Test tubes with formalin solution
- Prefilled with four percent formalin solution
 - Available in different sizes
 - Individual labelling possible

Microscopy

Olympus – BX53LED



- Highlights:**
- Dedicated LED light source for microscopy (Olympus True Color LED)
 - Ergonomic design for intensive daily usage
 - Highly expandable frame to follow evolving application needs

The BX53 microscope's ergonomic design helps you stay comfortable during extended periods of use while the intuitive control layout enables fast, efficient observation and imaging. Optimized for laboratory applications, Olympus exclusive True Color LED illumination has a high luminosity and color rendering index so you can see samples in real-to-life colors avoiding color casts of generic LED light sources.

Olympus – UC90 4K Microscopy



- Highlights:**
- Up to 4K UHD image capturing
 - One Camera for Multiple Applications
 - 9-megapixel CCD camera

The 9-megapixel UC90 camera captures it all: brightfield images of superior quality, and up to 4K UHD imaging. Whatever your imaging needs are, expect no less than exceptional results in image quality, sensitivity, dynamic range, and color fidelity. The UC90 offers fluid sample navigation and focusing, making it effortless and convenient to locate regions of interest right on your screen. Excellent microscope imaging has never been as easy and versatile as with the UC90.

Information Technology

CliniSys | MIPS – DaVinci



Highlights: DaVinci – user-friendly solution designed by pathologists for increased productivity

With DaVinci, you can optimise your pathology processes, and your employees can work more efficiently and more collaboratively. Results are available quicker and, of course, this benefits the patients. DaVinci supports all traditional pathology processes, with user-friendly and task-oriented workflows – starting from order communication and registration all the way to the delivery of the results.

Grossing Station

Kugel medical – Grossing table UCS-2000-D-E



Highlights:

- Down draft grossing table for histo-pathology lab
- Fully made of stainless steel
- Double workstation with large working surface
- Integrated washbasin with air extraction
- Large legroom on both sides
- Electrical adjusted in height for working in a sitting or standing position
- Lighting frame construction with high power LED
- Extensive accessories such as monitor holder, scanner holder, camera holder available
- Tables are available in different lengths

Kugel medical – Grossing table GP-2000 with carbon filter system



Highlights:

- Down draft grossing table with recirculation air system
- Stand-alone table without separate exhaust air system
- Workstation with large working surface
- Large legroom along the table
- Infinitely adjusted in height for working in a sitting or standing position
- Lighting frame construction with high power LED
- Extensive accessories such as monitor holder, scanner holder, camera holder available
- Durable activated carbon filter cartridge

Kugel medical – Laboratory bench LT-1000-AK-ULS



Highlights:

- Special design for small histological preparations
- Down draft grossing table with recirculation air system
- Stand-alone table without separate exhaust air system
- Fully made of stainless steel
- Workstation with removable working plate
- Durable activated carbon filter cartridge
- Available in different lengths

Coverslipper

Medite – Film Coverslipping Automat Twister



- Highlights:** Fast and easy coverslipping with the Twister Film Coverslipper – Made in Germany!
- Excellent results: perfect for digital slide scanners
 - Fast processing: up 1,200 slides per hour
 - Non-stop operation: continuous insertion and removal of slide baskets
 - Intuitive touch screen: easy navigation and adjustment of parameters by using icons
 - Matching coverslipping film CytoTape (made in Germany) available

Sample Collection

Sarstedt – S-Monovette RNA Exact



- Highlights:** For increasingly performed gene expression analyses Sarstedt offers the new S-Monovette RNA Exact, which conserves the gene expression pattern which is present at the time of blood collection, and makes it accessible to all subsequent analyses. Already during the sampling it comes to stabilization of all RNAs contained, and the induction of irrelevant transcripts (stress genes) is additionally prevented. The S-Monovette RNA Exact standardizes the preanalytics of gene expression analyses and brings a significant simplification for the daily laboratory routine and especially for multicenter studies.

healthcare-in-europe.com
Stay informed

- News
- Reports
- Interviews
- Videos
- Social Media



EUROPEAN HOSPITAL

DNA

HOLOGIC[®]

Lifotronic

 **MOLGEN**

 **Promega**

 **QUIDEL**

 **SARSTEDT**

SIEMENS
Healthineers

Snibe
Diagnostic

 **zybio**

Amplification
Amplification / Detection
Extraction
Infectious Disease
Infectious Disease /
Hepatitis
Sample Collection
Detection
Purification
Reagents
Research Use Only

Amplification

Sarstedt – White Multiply PCR Plates



Highlights: In addition to a generally improved quality, Sarstedt now offers optimized white color variants for better detection sensitivity in qPCR. In addition, we have expanded our PCR plate range with high-purity EtO-treated variants (Biosphere plus quality) as well as DNA & protein low binding variants. With our Biosphere plus variants, we offer the maximum and unsurpassed purity standard for an absolutely reliable absence of DNA or other biomolecules. The low binding variants are our contribution to the increasing use of PCR consumables for other applications, e.g. for sample storage of smallest volumes or for preparing dilution series so that all biomolecules can be recovered from the wells.

Amplification/Detection

Quidel – Savanna – Real-time PCR technology



Dimensions: 210 × 254 × 254 mm (h × w × d) – small size
Power consumption: RVP4 (SARS-CoV-2 Influenza A, Influenza B, RSV), RVP11*, GI Panel*, STI Panel*
 *New test in development

Highlights:

- True sample to result platform with no up-front sample or reagent preparation
- One sample with multiple results
- Delivering customized rapid, molecular results [fast turnaround time (< 25 min RVP4)] with test select feature – select parameters now and recall other results within 48 hours
- Efficient nucleic acid isolation via magnet beads
- Room temperature storage
- Low capital and disposable costs

Extraction

Lifotronic – Nucleic Acid Extraction Kit



Highlights:

- Multiple packs are available: 1T / 8T / 64T / 96T
- Magnetic beads-based technology
- Suitable for extraction of DNA & RNA from different viruses
- Pre-loaded reagent for easy operation
- High efficiency with 32 samples in 10 min
- High purification & elution efficiency: > 98%

MolGen – PurePrep 96



Highlights: The PurePrep 96 is an automated nucleic acid extraction system and suitable for high throughput workflows.

- High-quality processing of up to 96 samples per run
- Wide volume range: 50 – 1000 µL
- Compact, user-friendly and easy to install

This device uses magnetic separation technology to process matrices such as blood, cultured cells, bacteria, tissues, cell-free body fluids, and plant samples, moving each through the various purification phases of mixing, binding, washing and elution, resulting in purified DNA and RNA.

AD CORP 0008 V1.0 15-NOV-2021

Providing innovative molecular workflows to empower future diagnostics



MolGen PurePrep 96

Founded in 2018 as a DNA extraction chemistry company, Dutch company MolGen entered the market operating within the agricultural sector. At first, the company's founders, Maarten de Groot, Wim van Haeringen and Niels Kruize, focused solely on this one industry, mainly developing and marketing advanced bulk chemistry kits for DNA/RNA extraction. These testing products and solutions successfully satisfied the needs of the seed and plant breeding industry. Things changed drastically for the company, though, with the unexpected arrival of the COVID-19 pandemic.

The company of three suddenly found itself with an unprecedented opportunity. In the early part of 2020, there was a shortage of testing capacity in The Netherlands and around the world, for that matter. Knowing it had as a strong experience as a DNA extraction chemistry company and years of experience in life sciences, MolGen responded to an invitation by the Ministry of Health, Welfare and Sport to offer a solution of procuring and supplying testing equipment to the Dutch government. At the time, the Dutch authorities were under prepared and overwhelmed with the testing capacity required to handle such a large disruption, and MolGen

soon became one of the providers of the country's SARS-CoV-2 detection tests. A year later, the company had 50 full-time employees and is building an international network with a very large customer base relying on its safe, efficient, affordable solutions that scale-up testing capacity. Soon MolGen was supplying mobile labs and consumables for public health authority test centers in cities including Amsterdam, Rotterdam, and Utrecht.

In early 2021, MolGen continued to meet the market demands of purification solutions for DNA and RNA testing and other forms of molecular diagnostics. Helping to accelerate the company's growth was the decision to evolve its offerings to include technology, systems, laboratory consumables and kits for human and animal diagnostics, as well as solutions for the agriculture and biotech industries.

"To achieve our mission of connecting people with life science, we provide the highest quality products and solutions that achieve greater automation, efficiency and scalability to those who are dedicated to the betterment of our world."

Maarten de Groot, MolGen CEO

In the area of human and animal diagnostics applications, MolGen develops and globally markets an advanced molecular total solution that has several applications – from the diagnosis of SARS-COV2 to generic variant screening to Influenzae screening and other applications. Its extraction and testing solutions, products and equipment are designed to achieve increased automation, reduced laboratory time, high yields and reproducibility. Now able to test everything from blood to cultured cells to bacteria to tissue and cell-free body fluids, MolGen's throughput workflows enable the creation of future-ready, professional-grade laboratories that feature specialized components that leverage highly-effective protocols that improve workflow, safety and results rate.

Leaning into its legacy capability, MolGen continues to offer advanced extraction and testing products and solutions directed at the agriculture industries. Having developed a range of tools, the company has grown to offer technologies and procedures that are deployed in plant and crop-specific diagnosis. This growth has led the company to be a vital part in the championing of sustainability and ecosystem protection. Expanding the company's impact further is its investment in biotech solutions directed at the genetics branch across the food, pharma and biopharma industries. Within



At MolGen: Wim van Haeringen, CTO, Maarten de Groot, CEO, and Niels Kruize, CCO (from left to right)

this branch, the company is revolutionizing research by providing highly accurate, fast throughput, easy to handle, reliable systems and products for next-generation research genetics, in order to improve the health and well-being of all.

"By investing in human and animal diagnostics and the agricultural and biotech industries, we've become the comprehensive solution that guarantees quality, flexibility and adaptability in all areas of life science testing."

Wim van Haeringen, MolGen, CTO

Today, MolGen has grown to over 100 employees and continues to invest in new products, lines, new markets and global communications. While the company has established long-term partnerships with large renown service laboratories, scaling up their SARS-CoV-2 test capacity successfully, MolGen is now expanding internationally, bringing its DNA/RNA extraction product offering to the US market. An office has already been opened in the United States and in the United Kingdom, while a logistics hub in China will be established by the end of 2021. From sample to result, MolGen is challenging the status quo in molecular diagnostics by offering platform-agnostic, stand-alone systems and consumables, and combining multiple systems into complete diagnostic flows that are high-quality, adaptable and safe.

In June 2021, SpeedX Pty, Ltd. and MolGen announced the signing of an agreement to collaborate on supply and distribution of clinical diagnostics products and instrumentation across Europe and Asia Pacific. The partnership links specimen handling, nucleic acid extraction, assay set-up, amplification, and results reporting in a seamless integration of the companies technologies.

The tremendous growth by MolGen has only strengthened the company's resolve to find even more avenues for partnership in order to create greater cost efficiencies and bring the most advanced equipment to laboratories and emerging markets around the world. Additionally, the company is leading the charge for a concept known as monitoring – a pay-by-sample testing method that enables accurate analysis at scale and a lower cost. As society fights to regain normalcy by re-opening its businesses and schools,

MolGen is introducing a solution to keep them open. Though the use of spit cup samples that are collected more frequently, and far less invasively than nasal swab tests, monitoring results in more transparency and more reassurance that every precaution is being taken for the sake of all. Reducing the costs of testing through monitoring not only ensures that people participate, it helps mitigate the risks of unsafe self-testing and antigenic testing that has been prevalent throughout the pandemic.

"Beyond the pandemic, our vision is to expand to serve more industries in more ways. Beyond testing and diagnostics, we will pioneer the concept of high-frequency testing, or monitoring, to redefine how the world looks at disease and other life science conditions now and in the future."

Niels Kruize, MolGen CCO



MolGen PurePrep TTR



CONTACT

MolGen
Traverse 2, 3905 NL, Veenendaal, The Netherlands
info@molgen.com · molgen.com

Extraction

MolGen – PurePrep Pathogens Kit



- Highlights:** The PurePrep Pathogens kit is intended for manual and automated DNA and RNA isolation from a wide range of matrices.
- Safe handling of potentially infectious samples (like COVID-19)
 - Processing time for the preparation of 96 samples is about 40 minutes
 - Suitable for processing various sample materials
- The kit can be used on the PurePrep 96 and PurePrep 32. This kit is also compatible with similar systems or on other automated DNA purification instruments.

AD CORP 0009 V1.0 15-NOV-2021

Promega – Maxwell CSC Instrument



- Dimensions:** 330.2 × 299.7 × 345.2 mm (w × h × d)
Weight: 11 kg
Sample throughput: up to 16 samples / 24 – 72 minutes
Handheld/Stationary: Very small benchtop instrument
Assays: Blood, FFPE (CE-IVD) or plasma, swabs, cells, saliva and many others (RUO)

- Highlights:** Automated DNA and RNA extraction for IVD use
- Generates consistent, high-quality nucleic acid for use in downstream diagnostic amplification assays
 - Works with multiple sample types, e.g., blood, FFPE (CE-IVD) or plasma, swabs, cells, saliva and many others (RUO)
 - Paramagnetic particle use = no cross-contaminations
 - Designed and manufactured under cGMP
 - Reliable sample tracking with integrated barcode scanner
 - Technical features support 21 CFR Part 11 compliance
 - Flexible, dual-mode software with separate RUO mode for research-based DNA & RNA extractions

Promega – Maxwell CSC 48 Instrument



- Dimensions:** 533.4 × 355.6 × 533.4 mm (w × h × d)
Weight: 27 kg
Sample throughput: up to 48 samples / 23 – 69 minutes
Assays: Blood, FFPE (CE-IVD) or stool, plasma, swabs, buffy coat, cells, saliva, food and many others (RUO)

- Highlights:** Automated nucleic acid extraction for IVD use
- Extraction of high-quality nucleic acid with minimal hands-on time
 - Processes different sample types for downstream applications in molecular diagnostics, IVD-compliant
 - Paramagnetic particle use = no cross-contaminations
 - Integrated vision system for error prevention
 - Reliable sample tracking with integrated barcode reader
 - Designed and manufactured under cGMP
 - Technical features support 21 CFR Part 11 compliance
 - Dual-mode software for both molecular diagnostics (IVD-mode) and research applications (RUO-mode)

Snibe – Molecision MP-32



- Dimensions:** 460 × 392 × 470 mm (w × d × h)
Weight: 33 kg
Sample throughput: 1 – 32 tests/h

- Highlights:** Molecision MP-32 is a fully-auto nucleic acid extraction instrument towards good and efficient preparation for varieties of applications such as PCR, RT-PCR, sequencing, etc.
- Fully automated workflow to minimize handling error
 - Optimized reaction conditions ensure the efficient recovery of nucleic acid and good extraction stability
 - Double extraction module, can execute different extraction procedures separately
 - High-efficiency HEPA filter cotton, with automatic negative pressure exhaust function, to avoid aerosol pollution
 - Pre-pack reagents and disposal 8-strip tips to avoid cross contamination
 - Broad range of supported samples

Smart simplicity

IN ON-DEMAND TESTING



A simple and fast way to pinpoint patients most at risk with targeted and syndromic on-demand testing.

Our high multiplex technology is precision engineered for simplicity and accuracy across a broad and growing assay menu.

The Novodiag[®] System is part of our world leading Molecular Scalable Solutions, designed to effortlessly help you to meet the growing demands of your lab, today and in the future.

LEARN MORE



ADS-03410-EUR-EN Rev 001 © 2021 Hologic, Inc. All rights reserved. Hologic, Novodiag and associated logos are trademarks and/or registered trademarks of Hologic, Inc. and/or its subsidiaries in the United States and/or other countries. This information is intended for medical professionals and is not intended as a product solicitation or promotion where such activities are prohibited. Because Hologic materials are distributed through websites, eBroadcasts and tradeshow, it is not always possible to control where such materials appear. For specific information on what products are available for sale in a particular country, please contact your local Hologic representative or write to euinfo@hologic.com.

HOLOGIC[®]
NOVODIAG

Extraction

Snibe – Molecision MP-96



Dimensions: 992 × 392 × 478 mm (w × d × h)
Weight: 33 kg
Sample throughput: 1–96 tests/h

Highlights: Molecision MP-96 is a fully-auto nucleic acid extraction instrument that meets the vast demand for nucleic acid testing and can apply to scientific research, clinical diagnosis, disease control, food safety, forensic medicine and other fields

- Efficient – fully automated workflow
Pre-filled reagents
- Flexible – broad range of supported samples
Compatible with different reagents
- Safe – high efficiency HEPA filter cotton
UV lamp disinfection
- Friendly – easy operation, simplified workflow
High resolution color touch screen

Snibe – Molecision Nucleic Acid Extraction Kit



Highlights: Molecision Nucleic Acid Extraction Kit serves as a one-stop solution for DNA/RNA extraction. There are two versions of kit according to different requirements: fast version (7 min) and standard version (30min)

- Optimized reaction conditions ensure the efficient recovery of nucleic acid and good extraction stability
- The nucleic acid isolation procedure is based on the silica magnetic glass particles as a solid-phase support technology
- Suitable for plasma, serum, whole blood, sample preservation solution from oropharyngeal swabs and nasopharyngeal swabs, cultured cells and fresh-frozen tissue
- Materials required such as 8-Strip Tips and 96-Well Deep-Well Plate are included

Zybio – EXM3000 Nucleic Acid Purification System



Dimensions: 375 × 415 × 440 mm (d × w × h)
Sample throughput: up to 32 samples per run
Assays: Nucleic extraction for virus, bacteria, stool, FFPE, whole blood samples
Max. input power: 500 VA
Operation interface: 8.4 inch touch screen

Highlights:

- Fast extraction speed, 9 minutes for 32 viral samples
- Compact design provides the ability to operate in biological safety cabinet
- 5500GS magnetic flux and 98%+ magnetic bead recovery rate, providing high quality purification
- Equipped with ventilation facilities, HEPA filter and negative pressure exhaust function. Automatic alarm system and software reminder are also provided

Zybio – EXM6000 Nucleic Acid Purification System



Dimensions: 696 × 450 × 460 mm (d × w × h)
Sample throughput: up to 96 samples per run
Assays: Nucleic extraction for virus, WB, FFPE, bacteria, stool extraction kit
Max. input power: 500 VA
Operation interface: 8.4 inch touch screen

Highlights:

- Fast extraction speed, 12 min for 96 viral samples
- 5500GS magnetic flux and 98%+ magnetic bead recovery rate, providing high quality purification
- Compatible with extraction kits for different samples such as WB, FFPE, stool, etc.
- Equipped with ventilation facilities, HEPA filter and negative pressure exhaust function. Automatic alarm system and software reminder are also provided

From Sample to Result



PROVIDING INNOVATIVE MOLECULAR WORKFLOWS TO EMPOWER FUTURE DIAGNOSTICS

MolGen is a total solutions global supplier of innovative extraction DNA / RNA technology, systems, products and kits for human and animal diagnostics, agriculture, aquaculture, pharma and biotech.

From sample to result, MolGen is challenging the status quo in molecular diagnostics by offering platform-diagnostic stand-alone systems and consumables. Highly customizable, our portfolio offers the perfect workflow for our customers' specific needs.

Please contact us for more information about our flows, systems, kits and consumables.

COMPLETE DIAGNOSTICS WORKFLOW

including, assay, consumables and chemistry

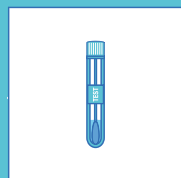

PUREPREP TL+

1

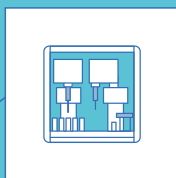

PUREPREP TUBE TRANSFER SYSTEMS

2

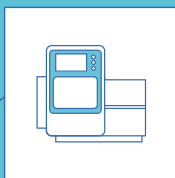

PUREPREP EXTRACTION SYSTEMS

3

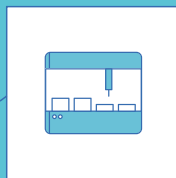

PUREPREP FR

4

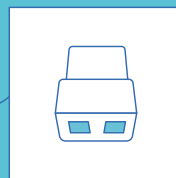

REAL TIME ANALYZER

5



PUREPREP ANALYSIS

6

Extraction

Zybio – Nucleic Acid Extraction Kit



- Highlights:** The kits are designed for samples from different sources. Besides regular manual operation kit, there are also pre-filled and ready-to-use kits that are available for Zybio automatic isolation systems, which make the nucleic acid extraction easier and much faster.
- Flexible extraction method, manual operation and to operate with nucleic acid isolation system (EXM3000 and EXM6000)
 - Fast extraction speed, only 9–12 minutes for 32–96 samples by Zybio isolation systems
 - Multi-sample types, such as serum, plasma, nasopharyngeal swab, cell preservation solution, tissue fluid, urine, secretions, etc.
 - High nucleic acid recovery rate ($\geq 90\%$), high repeatability

Infectious Disease

Hologic – Novodiag System



- Dimensions:** 490 × 330 × 570 mm (w × h × d)
for one instrument configuration
- Sample throughput:** 1–128 tests per 24 hours

- Highlights:** The Novodiag System offers a simple and fast way to pinpoint patients most at risk with targeted and syndromic on-demand testing.
- Offers a wide menu of targeted and multiplex assays in one instrument
 - Clear displays of results in around an hour
 - Small, quiet, fully automated easy-to-use platform
 - Up to four instruments can be stacked and controlled by a single computer (Novodiag Plus)
 - Part of Hologic Molecular Scalable Solutions portfolio

Siemens Healthineers – Fast Track Real-time PCR assays

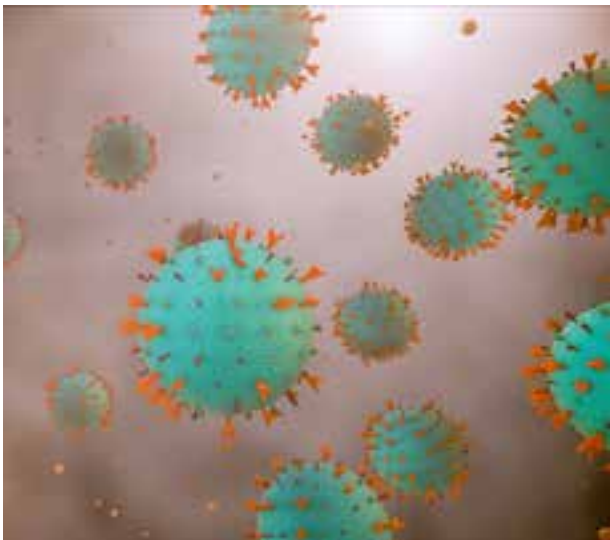

- Highlights:** Siemens Healthineers enables precision medicine, with molecular testing solutions for the detection of major infectious diseases; monitoring of treatment efficacy; and selection of individualized treatment options. Our one-step syndromic real-time PCR products* simultaneously detect viruses, bacteria, and parasites, allowing molecular laboratories to lower cost and drive better outcomes.

*Product availability will vary by country.

Snibe – Molecision SARS-CoV-2 RT-PCR Assay



- Highlights:**
- Optimized reaction conditions ensure the efficient recovery of nucleic acid and good extraction stability
 - The nucleic acid isolation procedure is based on the silica magnetic glass particles as a solid-phase support technology
 - Suitable for plasma, serum, whole blood, sample preservation solution from oropharyngeal swabs and nasopharyngeal swabs, cultured cells and fresh-frozen tissue
 - Materials required such as 8-Strip Tips and 96-Well Deep-Well Plate are included

Infectious Disease

Snibe – Molecision SARS-CoV-2 RT-PCR Assay (Lyophilized)



- Highlights:** The new version of Molecision SARS-CoV-2 RT-PCR Assay is a lyophilized, easy-transporting and one-step RT-PCR assay for the qualitative detection of nucleic acids from SARS-CoV-2
- One-step, lyophilized and easy-transporting assay
 - Ambient temperature transportation
 - Includes Negative and Positive Controls
 - Results available around 60 minutes after extraction
 - An endogenous internal standard detection system

Snibe – Molecision SARS-CoV-2 & Flu A/B RT-PCR Assay



- Highlights:** In one tube, meet the needs for the screening of SARS-CoV-2, Influenza A and Influenza B
- Efficient (Simultaneous detection of SARS-CoV-2 and influenza A/B virus)
 - High specificity, high sensitivity and good repeatability
 - Compatible with various sample types and instruments
 - Amplification time is 56 min

Snibe – Molecision SARS-CoV-2, Flu & RSV RT-PCR Assay



- Highlights:** New assay for SARS-CoV-2, Flu and RSV identification from a single respiratory sample
- Efficient (Simultaneous detection of SARS-CoV-2 and influenza A/B and RSV)
 - Compatible with various sample types and instruments
 - High specificity, high sensitivity and good repeatability

Infectious Disease / Hepatitis

Siemens Healthineers – Versant HCV Genotype 2.0 Assay (LiPA)



- Highlights:** Optimize your laboratory's testing with the widely used Versant HCV Genotype 2.0 Assay (LiPA)*.
- LiPA utilizes reverse-hybridization technology to detect HCV genotypes 1–6 and subtypes 1a and 1b.
 - LiPA provides highly accurate identification of HCV genotypes and subtypes for optimal and personalized patient therapy.

*LiPA assay is FDA-approved in the U.S. and CE-marked in the EU for IVD use.

Sample Collection

Zybio – Disposable Virus Sampling Tube



- Highlights:** Disposable Virus Sampling Tube adopts efficient virus inactivation technology and special flocked swab. It can be used for the collection and storage of clinical novel coronavirus, influenza, avian influenza (such as H7N9), hand-foot-mouth virus, measles and other virus specimens, as well as chlamydia, mycoplasma, and ureaplasma.
- Added cryoprotectant and biological buffer are conducive to the long-term preservation and maintaining the nucleic acid stability of the virus
 - Flocked swabs ensure the maximum amount of sample sampling and release
 - Non-inactivated and inactivated sampling tube, meets your different clinical needs
 - Can be used for the extraction of multiple viruses

Detection

Lifotronic – SARS-CoV-2 Nucleic Acid Detection Kit



- Highlights:**
- 2-Gene/3-Gene Detection Kit
 - Freeze-dried Detection Kit
 - Gene-Mutation Detection Kit
 - High precision with $CV \leq 5\%$
 - Effective for delta variant and other variants
 - Specific detection: ORF1ab gene and N gene
 - Rapid& large-scale test: 96 tests within 90 min
 - High sensitivity: 200 copies/mL
 - Applicable for various RT-PCR systems

Zybio – SARS-CoV-2 Nucleic Acid Detection Kit



- Highlights:** This product qualitatively detects the RNA of SARS-CoV-2 in the specimen through measuring the change of fluorescence signal intensity during RT-PCR amplification with specific primers and probes against the conserved region of ORF 1ab and N gene, using One Step RT-PCR method. The UNG-dUTP was used to minimize the possibility of contamination of PCR amplification products. In the meantime, thanks to the internal positive control, it can avoid false negative result in PCR amplification.
- Support of multi-sample types, nasopharyngeal swabs, sputum, bronchoalveolar lavage fluid, stool, etc.
 - Low limit of detection, 200 copies/mL, use ORF 1ab and N gene as detection target
 - Full monitoring, false negative possibility can be reduced by monitoring the extraction and detection with internal control. UNG-dUTP to eliminate cross-contamination
 - Applicable instruments, ABI 7500 Real-Time PCR System, SLAN-96P Real-Time PCR System and other PCR systems with FAM, VIC/HEX and ROX channels

Lifotronic – PureStar-32 Automated Nucleic Acid Purification System



- Highlights:**
- Easy to set up for a fast start
 - Built-in UV lamp for decontamination
 - High collection efficiency of the particles: $\geq 98\%$
 - 7-inch LCD touch screen
 - Benchtop system and user-friendly software

Reagents

MolGen – PurePrep TL+

Highlights:

Offering the combination of the safe transfer of viruses and lysis in one tube, the PurePrep TL+ buffer optimizes research.

- Compatible with most liquid handling systems
- Decreases prep time
- Improves workflows as it breaks down viscous samples within the tube

The PurePrep TL+ buffer is suitable for diagnostic tests and molecular biology techniques, facilitating processes like nucleic acid extraction. Its unique composition and features make it ideal to test procedures against SARS-CoV-2.



AD CORP0010 V1.0 15-NOV-2021

Research Use Only

Sarstedt – Low DNA Binding Micro Tubes



Highlights:

As the trend towards decreasing sample volumes continues, it is increasingly important to minimize potential interaction between the analyte and tube. Our low protein and new low DNA binding micro tubes are specifically designed to meet the requirements in protein and DNA analytics while maximizing recovery rates.

Lifotronic

— Caring for Better Life —

Immunoassay and Biochemistry

Hematology

Whole Blood Diagnosis

HPLC

POCT

FIA

Extraction System

Molecular Diagnosis

Detection Kit

Four Technology Platforms

*Featured and specialized *IVD products supplier

Microbiology

Mass Spectrometry
Microscopy
Identification /
Susceptibility



hund
WETZLAR

OLYMPUS

Your Vision, Our Future

 **SHIMADZU**
Excellence in Science

 **zybio**

Mass Spectrometry

Shimadzu – Axima iDplus Assurance



Dimensions: 700 × 1920 × 850 mm (w × h × d)
Weight: 330 kg, excluding data system

Highlights: Axima Assurance – flexibility and quality: The Axima Assurance is designed with the general analytical and life science laboratory in mind. Incorporating a variable repetition rate 50 Hz N₂ laser, the system provides high quality and high sensitivity rapid MALDI mass spectra and is particularly suited to identification in the microbiology field. Positive and negative ion modes are included as standard, allowing greater flexibility and extending the compound categories that may be analysed.

Shimadzu – Axima iDplus Confidence



Dimensions: 700 × 1920 × 850 mm (w × h × d)
Weight: 330 kg, excluding data system

Highlights: iDplus Confidence – sensitivity and flexibility:

- Rapid microbial identification for research use
- Identifies and classifies strains based on phenotype characteristics
- SuperSpectra reduce the incidence of false positives and ensure robustness and reproducibility
- Open system allows addition of new species / entries to the database or the creation of new databases
- Clustering allows molecular profiling and tracking of change or evolution
- High performance MS for large molecule analysis
- MS/M

Shimadzu – Axima iDplus Performance



Dimensions: 700 × 1920 × 850 mm (w × h × d)
Weight: 375 kg, excluding data system

Highlights: iDplus Performance – application-centric solutions:

- Rapid microbial identification for research use
- Identifies and classifies strains based on phenotype characteristics
- SuperSpectra reduce the incidence of false positives and ensure robustness and reproducibility
- Open system allows addition of new species / entries to the database or the creation of new databases
- Clustering allows molecular profiling and tracking of change or evolution
- High performance MS for large molecule analysis
- MS/MS

Shimadzu – Maldi-8020



Dimensions: 450 × 1055 × 745 mm (w × h × d)
Weight: 86 kg

Highlights: The Maldi-8020 is a benchtop, linear-only MALDI-TOF mass spectrometer designed to meet the needs of laboratories requiring a cost-effective MALDI-TOF platform. This newly designed MALDI-TOF mass spectrometer is functionally simple but provides outstanding MS performance in a compact footprint.

From serum to result in one hour

Fungitell STAT explained



Fungitell® is an adjunct diagnostic assay to be utilized in conjunction with clinical signs and symptoms for the diagnosis of invasive fungal infection. Fungitell is currently 510(k) cleared for the detection and quantification of (1→3)-β-D-glucan in human serum and should be used and interpreted only in a manner consistent with the current instructions for use. Single or small numbers of (1→3)-β-D-glucan (BDG) tests are required in emergent and acute care as well as in low patient sample number settings. Fungitell STAT is a simple, fast (1 hour), and small footprint approach to testing 1–7 patient serum samples [Figure 1].

Figure 1: Fungitell STAT PKF08 Instrument
The instrument is small in size: 174 mm × 119 mm × 37 mm weighing approximately 1 kg. The power supply is EU friendly. The tablet and barcode reader are presented for size reference.

Based upon the well-known Fungitell microplate-based assay, Fungitell STAT is also a Limulus Amebocyte Lysate kinetic assay that is specific for (1→3)-β-D-glucan (BDG) [Figure 2]^{1,2,3,4,5}. The Fungitell STAT method employs a standard in place of the standard curve utilized in the Fungitell method. This Fungitell STAT standard is a critical element of the test and is designed to represent the rate of a reaction for a sample of glucan at 80 pg/mL. This pg/mL value is based upon the cutoff in, and derived from, the execution of the Fungitell predicate assay. The Fungitell STAT standard is run in parallel with a sample (or samples) to which it is compared using the same treatments



CONTACT

Associates of Cape Cod Europe GmbH
Opelstraße 14 · 64546 Mörfelden-Walldorf, Germany
tel +49 61 05 96 10-0
service@acciusa.de
www.acciusa.de

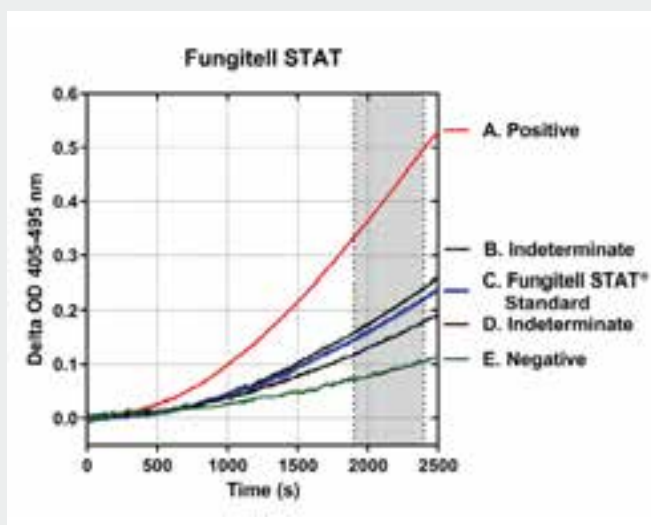

Figure 2: Illustration of underlying kinetic curves derived from the Fungitell STAT method. Samples on the graph: A. is positive and B. and D. are indeterminate, C. Fungitell STAT Standard; E. negative. All plots are delta OD 405 – 495 nm. The gray zone between 1900 and 2400 seconds is the area of linear regression from which rates are determined.

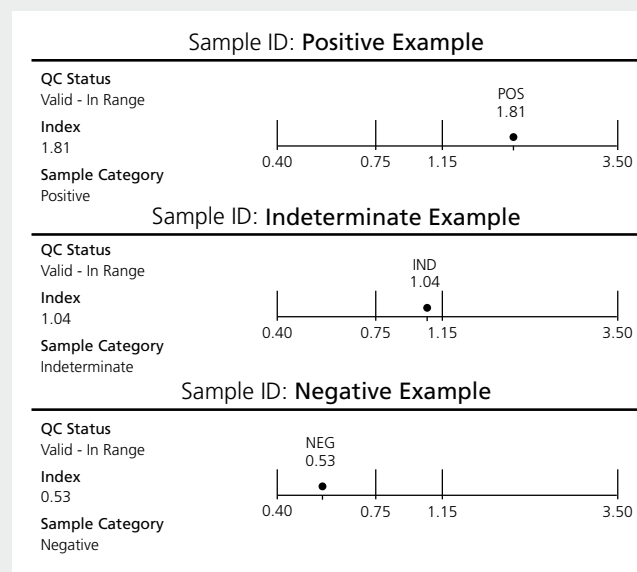

Figure 3: Example output from a Fungitell STAT assay as reported by the new BG Analytics (BGA) software.

and materials. A simplified method for execution is outlined below in Table 1. With this approach, an emergency department lab or main lab can quickly run one to seven patient tests at a time, saving days over a send-out approach. The output for the Fungitell STAT method is a comparative index (beta glucan index, BGI, [Figure 3]) computed by dividing the patient sample rate by the Fungitell STAT standard rate. This patient sample BGI value is qualitatively interpreted as a negative, indeterminate, or positive result according to the ranges provided in Table 2. The relationship of the STAT BGI output back calculated

into the pg/mL values of the more familiar Fungitell microplate kit is described in Table 2 as well.

Complementing the traditional Fungitell assay, used with high sample volumes, the Fungitell STAT permits clinical settings of any size to utilize rapid BDG testing in their patient care. Additional information is available at www.fungitell.com/fungitell_stat.

Step	Action
1	Add serum sample (50 µL)* to an empty vial /test tube
2	Add alkaline pretreatment to sample (200 µL), mix
3	Reconstitute the Fungitell STAT Standard (STD) with LRW (100 µL)*, mix
4	Add alkaline pretreatment solution (APS) to STD (400 µL)*, mix
5	Incubate samples and STD at 37oC for 10 min
6	Reconstitute Fungitell STAT reagent with LRW (300 µL), mix
7	Transfer 75 µL of STD to a Fungitell STAT reagent reaction vial, mix
8	Transfer 75 µL of sample to another Fungitell STAT reagent reaction vial, mix
9	Place reaction vials into instrument
10	Collect data

Table 1: Fungitell STAT simplified method outline

* The ratio, 1:4, with pretreatment for sample and standard is fixed, however, reconstitution volumes of the Fungitell STAT Standard (STD) will vary depending on lot. For example, the reconstitution volumes for the standard lot used in this table are 100 µL LRW:400 µL APS.

	A	B	C
Cutoff	Fungitell STAT IFU (BGI)	Fungitell Predicate (pg/mL)	FSTAT to FTELL Back calc. (pg/mL)
Negative	≤ 0.74	< 60	< 60
Indeterminate	0.75 – 1.1	60 – 79	60 – 88
Positive	≥ 1.2	≥ 80	≥ 96

Table 2: Fungitell STAT (BGI) and comparison to Fungitell (pg/mL)

Discussion References

- D’Ordine RL, Garcia KA, Roy J, Zhang Y, Markley B, Finkelman MA. Performance characteristics of Fungitell STAT, a rapid (1→3)-β-D-Glucan single patient sample in vitro diagnostic assay. *Med Mycol.* 2020 May 13. pii: myaa028. doi:10.1093/mmy/myaa028.
- Iwanaga, S., Miyata, T., Tokunaga, F., and Muta, T. 1992. Molecular mechanism of hemolymph clotting system in *Limulus*. *Thrombosis Res.* 68: 1-32.
- Tanaka, S., Aketagawa, J., Takahashi, S., Tsumuraya, Y., and Hashimoto, Y. 1991. Activation of a *Limulus* coagulation factor G by (1→3)-β-D-Glucans. *Carbohydrate Res.* 218:167-174.
- Saito, H., Yoshioka, Y., Uehara, N., Aketagawa, J., Tanaka, S., and Shibata, Y. 1991. Relationship between conformation and biological response for (1→3)-β-D-Glucans in the activation of coagulation factor G from *Limulus* amoebocyte lysate and host-mediated antitumor activity. Demonstration of single-helix conformation as a stimulant. *Carbohydrate Res.* 217:181-190.
- Aketagawa, J., Tanaka, S., Tamura, H., Shibata, Y., and Saito, H. 1993. Activation of *Limulus* coagulation factor G by several (1→3)-β-D-Glucans: Comparison of the potency of glucans with identical degree of polymerization but different conformations. *J. Biochem* 113:683-686.

Shedding light on the mysteries of rare microbial infections with MALDI-TOF MS

The Zybio EXS2600 mass spectrometry system enables rapid microbial identification, including bacteria and fungi. With an advanced pre-filled sample kit, user-friendly software and a comprehensive strain database, the EXS2600 offers high-throughput screening, convenient operation and accurate results.



EXS 2600 mass spectrometry system and several pretreatment reagent kits

How can the EXS2600 support microbiological analysis?

Zybio's 4th generation MALDI-TOF hardware, database and software have been optimized in several aspects, e.g. the signal-to-noise ratio is now 1,000 times better than in the original generation. Accuracy, resolution and sensitivity are better calibrated and synchronized. Compared with traditional biochemical identification methods, MALDI-TOF MS technology constitutes a quantum leap in terms of efficiency: the turn-around-time (TAT) was shortened by more than 10 times and identification accuracy is now at 95%+. MALDI-TOF is becoming increasingly popular due to its ease-of-use, productivity and revolutionary automation efficiency which reduce tedious labor and material consumption. Prompt accurate diagnostic results and proper therapeutic suggestions can save lives.

A comprehensive database and intelligent technology improve accuracy

The Zybio EXS2600 displays identification results and morphological reference intuitively with a clinical database of 5,000+ species covering 20,000+ strains, which meets modern labs' demands. Especially, delay extraction technology results in high resolution.

In order to improve ion transmission capacity and boost sensitivity, Zybio adopted a patented hyper-efficient ion propulsion technology that reduces ion jitter. Besides, the flight tube temperature compensation technology is integrated to ensure stability of the EXS2600.

Reliable and lean workflow enhances productivity

The efficient and cost-effective workflow of the EXS2600 is particularly popular with the end users. Notably, the oil-free vacuum pump requires no maintenance and the reusable target plate can contain up to 96 samples. This not only reduces measurement time at a high throughput of 96 samples per 12 minutes but also drives automation and simplifies repetitive tasks.

With its easy and user-friendly sample handling the EXS2600 also brings enormous benefits to microbiology labs in terms of one step to target-in for detection with reusable and traceable plates and pre-filled reagents, available in four different solutions. Strain identification in the EXS2600 reduces TAT from about 2 days to 15 minutes. All these

tools contribute to substantially reducing the laboratory's manual work and simplifying Standard Operating Procedures (SOPs).

Customized design powers up clinical research

Equipped with flexible cluster analysis software and artificial intelligence-powered typing software, the Zybio EXS2600 is excellently suited for clinical research, e.g. antibiotic-resistant bacteria research, serotypes and strain traceability analysis as well as identification of routine microbes and some difficult-to-identify bacteria. Moreover, due to the positive and

negative ion detector, the Zybio EXS2600 can be applied in phosphate protein detection among antibiotic-resistant bacteria and drug sensitivity analysis.

In addition to the wide range of application fields of MS in the investigation of drug resistance^{1,2} and identification of rare and difficult bacteria, such as *Mycobacterium*, *Nocardia* species and filamentous fungi (or molds), the Zybio EXS2600 has a self-built database which can further improve the detection ability of microbiology labs.³

"Since we introduced the Zybio EXS2600, the entire microbiology laboratory workflow has been ultra-elevated and streamlined with higher efficiency, shorter TAT, more trust from patients and clinical departments," says a chinese microbiology supervisor about his experience with EXS2600.

Zybio is dedicated to refining routine diagnostics with exquisite products and providing reliable microbiology solutions with an industry-leading microbiology system.

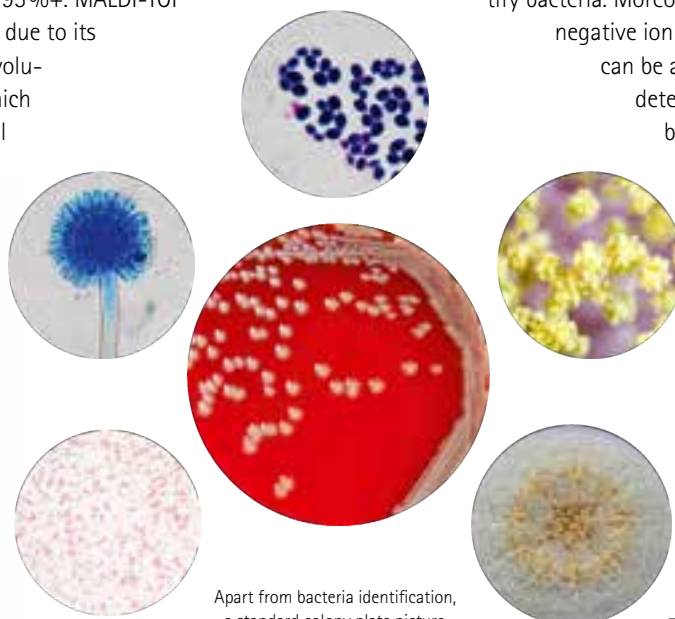

Apart from bacteria identification, a standard colony plate picture and a morphological reference picture support clinical decision-making.

References

- 1 Wang, Y., et al., Higher Prevalence of Multi-Antimicrobial Resistant *Bacteroides* spp. Strains Isolated at a Tertiary Teaching Hospital in China. *Infect Drug Resist.* 2020. 13: p. 1537-1546.
- 2 Liu, R., et al., Clonal Diversity, Low-Level and Heterogeneous Oxacillin Resistance of Oxacillin Sensitive MRSA. *Infect Drug Resist.* 2021. 14: p. 661-669.
- 3 Yu, K., et al., Establishment and Application of Matrix-Assisted Laser Desorption/Ionization Time-of-Flight Mass Spectrometry for Detection of *Shewanella* Genus. *Front Microbiol.* 2021. 12: p. 625821.



CONTACT

Zybio Inc.
No. 6 Taikang Road,
Block C, Jiangqiao Industrial Park, Dadukou District
Chongqing, China 400082
phone: +86 23 6869 9779
info@zybio.com · www.zybio.com

Mass Spectrometry

Zybio – EXS2600 MALDI-TOF Mass Spectrometry System



Dimensions: 490 × 800 × 1215 mm (w × d × h)
Weight: 116.1 kg

- Highlights:**
- Freely set calibration, quality control and sample spot for 96 positions
 - 400 million N2 laser beam shots, long life span and high-quality performance
 - Advanced MALDI-TOF technology test: 96 samples on one plate in only 12 min
 - Microbe can be directly identified from the blood culture positive bottle without the need for repeating subculture
 - Specified mold extraction reagents to simplify the mold pretreatment procedure which takes less than 2 min and improves repeatability

Microscopy

Hund – medicus pro Myko



Highlights: With the medicus pro Myko, a versatile laboratory microscope for medical practices, clinical laboratories and training, an easy and reliable detection of mycoses in native preparations becomes available. The dedicated fluorochrome, Mykoval, is easy to use and very cost efficient.

- High contrast and resolution
- No cultivation necessary
- Long lifetime of LED fluorescence illuminator
- Introductory price in 2020

Olympus – CX33



- Highlights:**
- Maintenance-free Koehler illumination with LED
 - Fully ergonomic design
- The CX33 microscopes enable users to remain comfortable during long periods of routine microscopy observations. The microscope frame conforms to the user's hands and the location of the control knobs maximize ergonomics to improve work efficiency. Users can quickly set a specimen with one hand, while adjusting the focus and operating the stage with the other hand with minimal movement.
- A fixed Koehler illumination system provides detailed images while minimizing the need for maintenance and the possibility of operator errors. The microscope also features an optional camera port for digital imaging.

Identification/Susceptibility

Associates of Cape Cod – Fungitell STAT Assay



- Highlights:** Fungitell, the gold standard in rapid screening for Invasive Fungal Infection (IFI), is now available in a single sample format. Fungitell STAT is the only single sample format FDA-cleared and CE marked rapid in vitro diagnostic screening test for IFI that detects (1→3)-β-D-glucan in serum.
- Test a single sample at a time
 - Rapid in-house results – within one hour eliminating the need for expensive send out services
 - CE marked single test (1→3)-β-D-Glucan assay – Reliable cut off values
 - Detects glucan from most fungi including candida, aspergillus and pneumocystis
 - Decreased turn-around-time – no more waiting for large, batched sample runs or send outs

FUNGITELL STAT[®]



Single Sample Format (1→3)-β-D-Glucan Testing For Better Turnaround Time And Better Patient Management!

Fungitell STAT[®] is the first and only single sample format
FDA-cleared and CE marked rapid *in vitro* diagnostic
screening test for IFI (including *Candida*, *Aspergillus* and
Pneumocystis) that detects (1→3)-β-D-Glucan in serum.

 **Fungitell**STAT[®]
(1→3)-β-D-Glucan Detection Assay
www.fungitell.com • (44) 151.547.7444
Associates of Cape Cod Int'l., Inc.



Early detection – new diagnostic possibilities with MS qPCR newborn screening

Since its introduction around 60 years ago, the screening of newborns for immune, hormone and metabolic disorders has prevented many children from experiencing severe disease progression. The scope of systematic early testing has been significantly enhanced through mass spectrometry (MS). In our interview, Professor Uta Ceglarek, one of the driving forces behind the introduction of MS procedures in newborn screening, outlines new diagnostic possibilities offered by MS and qPCR procedures for screening – and also the ethical limits and possible dangers of new regulations for their implementation.

Report: Daniela Zimmermann

The foundations for using drops of blood from newborn babies to make predictions about the development and prevention of diseases later in life were laid in the 1960s with the systematic screening of babies for phenylketonuria (PKU). Professor Ceglarek deems this a success story, confirming, "It has allowed us to diagnose diseases before symptoms develop."

The expert views the inherited metabolic disorder PKU as a prime example of the importance of screening: Those affected lack an important enzyme which results in the amino acid phenylalanine not being converted into tyrosine. When phenylalanine is ingested through food it accumulates in the body – with serious consequences. "Once these diseases take hold, the damage they cause is often irreversible."

Due to the lack of tyrosine, untreated PKU can lead to severe impact on brain development, with resulting intellectual disabilities. Prior to the introduction of newborn screening, those

affected required lifelong care and, in the most severe cases, had to be looked after in specialist care facilities. However, when PKU is detected early, the disorder can be managed well, with strict dietary measures, and specifically through the reduction of protein in the diet. "The first patients who had PKU diagnosed during newborn screening are now aged over 40 and, due to early detection of the disease, lead normal lives," Ceglarek points out.

MS/MS covers the lion's share

The range of diseases diagnosed through screening has increased significantly through the use of mass-spectrometry, and specifically through the tandem procedure MS/MS. The so-called enhanced newborn screening (funded by the statutory health insurers in Germany since 2005), currently includes 19 inherited diseases, nine of which are diagnosed via MS/MS [source: <https://www.screening-dgns.de/richtlinien.php>]. Additionally, PCR diagnosis, a procedure which has become more widely known to the public during the Corona pandemic, is used to diagnose severe combined immunodeficiency and spinal muscular atrophy. The prerequisite for screening inclusion is the existence of a reliable diagnostic procedure and the respective disorder being treatable. Although curative care is not possible in all cases, such as in the case of mucoviscidosis, early detection helps to delay the progression of the disease and to increase the quality of life for those affected.

In some cases, the therapeutic opportunities improve over the course of time, meaning that screening of newborns still makes sense. Currently, this includes spinal muscular atrophy (SMA), which can be safely diagnosed via PCR, but which cannot be cured. Zolgensma (AVXS-101), a new medication introduced only this year, has brought a cure for muscular atrophy within tangible reach. "Newborn screening for SMA started on 1 October 2021," Ceglarek reports. "The screening community is now observing with great interest how successful pre-symptomatic gene therapy will be."

New legislation threatens diagnostic options

The new version of the EU In Vitro Diagnostic Medical Devices Regulation (IVDR), which will finally come into force in 2022, will make the use of new, but also of already established, self-developed procedures much more difficult, Ceglarek says.

This also affects mass spectrometry. On the one hand, all procedures developed in the laboratory must be newly revalidated before they can be used on patients. "This means large, additional overheads for all para-meters which need to be reviewed," Ceglarek points out. On the other hand, the regulation prescribes the use of CE marked, commercially available laboratory tests. Even self-developed "in-house" solutions, so-called LDTs, can only be used when there is no equivalent product available in the

market, and only if they can prove full CE conformity. "The IVDR is not about economic efficiency, meaning that the use of a different procedure must always be justified with reasons other than cost efficiency. This means that in case of comparable analytical characteristics, the commercial method must always be used.

This also has devastating effects on molecular diagnostics, which, to a large part, works with self-developed reagents. "In our laboratory we are currently having to evaluate which LDTs we can realistically still offer," Ceglarek explains, adding: "If adherence to the IVDR had been compulsory at the start of the Corona pandemic, the initial supply of Covid LDTs would have taken a lot longer, because each procedure would have needed extensive validation before being used on patients."

The new regulation could therefore turn into a nail in the coffin for many laboratory-diagnostic procedures, such as those for diagnosis of rare diseases. "If the validation of these tests is this comprehensive, it will no longer be viable to offer them, so important diagnostic procedures will no longer be commercially available and cannot be offered as LDTs," Ceglarek says, appealing to those in charge, and calling for the IVDR to be modified before the end of the transition period.



PROFILE

Professor Uta Ceglarek is Deputy Director of the Institute of Laboratory Medicine, Clinical Chemistry and Molecular Diagnostics (ILM) at the University Hospital Leipzig, where she has been heading the Newborn Screening Laboratory since 2005. After completing her chemistry degree and a doctorate in analytical chemistry, Ceglarek completed further training in toxicology and clinical chemistry. In 2010 she was awarded her professorship, writing her habilitation on clinical metabolome research. Since 2000 she has been working on the use of mass-spectrometry diagnostics in newborn screening, for therapeutic drug monitoring and for metabolic indications. Ceglarek is also president of the German Society for Newborn Screening (DGNS) and speaker of the Section for Clinical Mass Spectrometry at the German Society for Clinical Chemistry and Laboratory Medicine (DGKL).

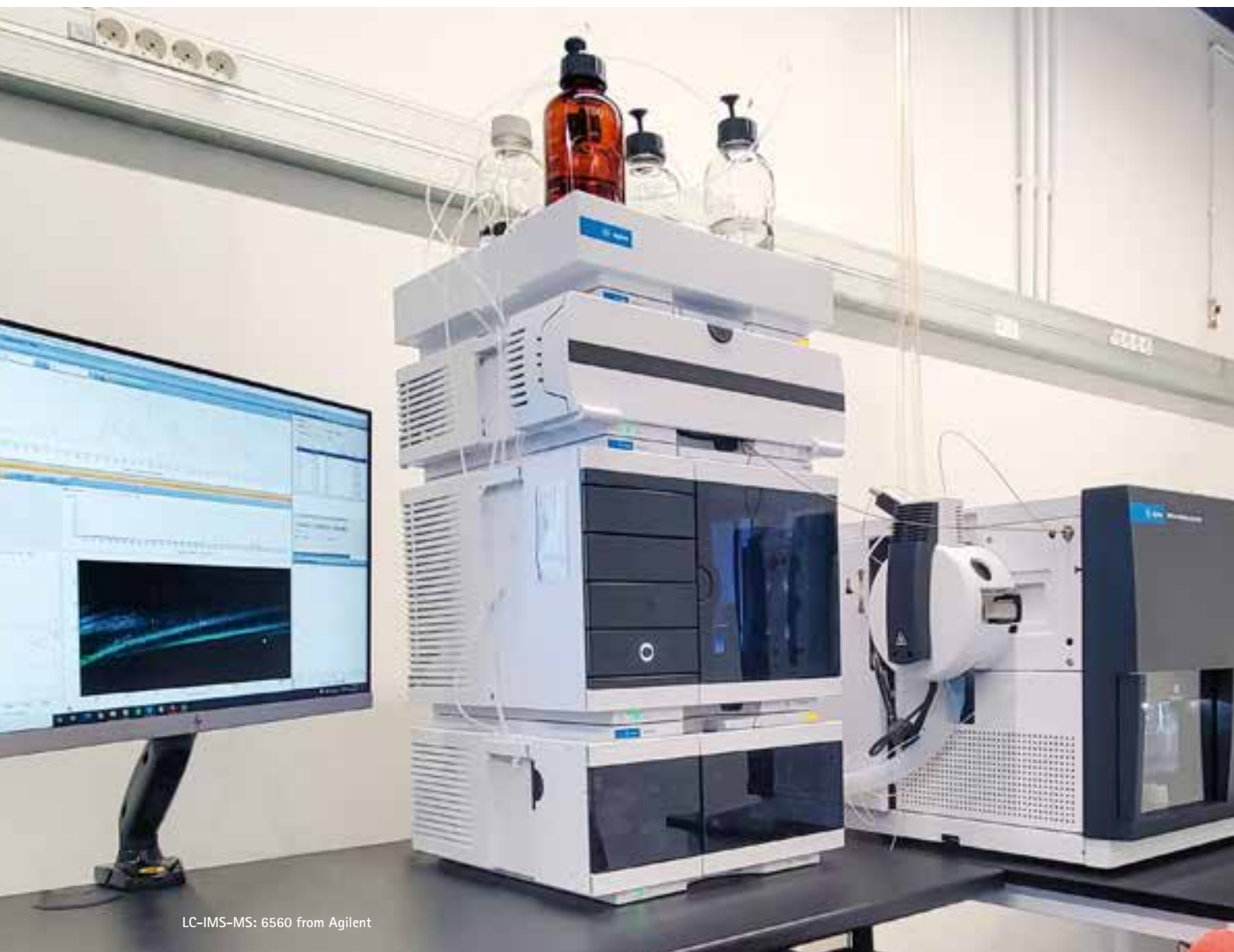

LC-IMS-MS: 6560 from Agilent

Rapid results from breath analysis – ion-mobility spectrometry

Ion-mobility spectrometry, a rapid separation tool, has clinical value in the identification and analysis of proteins, peptides, lipids, and glycans. The tool is already used as an exhaled drug monitor for anaesthetised patients.

It is flexible, portable and has use for point-of-care testing, or remotely where a patient does not need to be in a clinic, explained post-doctoral researcher Dr Raquel Cumeras.

Analytical technique

Ion-mobility spectrometry (IMS) is an analytical technique used to separate vaporised and ionised molecules based on their mobility under the influence of an electric field and their interactions with a carrier buffer gas.



As a rapid separation tool, it can be coupled with several sampling /ionisation methods, other separation techniques such as gas chromatography (GC-IMS), and various detectors, including mass spectrometry. Cumeras, who is a Marie Curie postdoctoral fellow at the Institute of Health Research Pere Virgili (IIPSV), and affiliated to the University Rovira i Virgili (URV) at the Department of Electrical Electronic Engineering and Automation in Tarragona, Spain, explained that the mobility is related to the chemical shape. "What makes it even more attractive is that it works in the millisecond range," she added, "making IMS perfect for analytical chemistry mass spectrometry instrumentation, where chromatography is in the second range, and mass detectors are in the microsecond range. So, IMS can be placed in between second > millisecond > microsecond."

In addition, Cumeras said a whole new branch of applications has emerged with liquid injection now possible (liquid chromatography – LC) with the new mass spectrometry instrumentation. These can include differentiation of isomeric chemical compounds, such as breath or volatiles for GC-IMS and proteins, peptides, lipids, and glycans for the LC-IMS-MS.

A complementary tool

Over the past two decades, IMS became established for the detection of illicit drugs or chemical warfare agents, but it is becoming attractive for use in clinical laboratories due to the high speed of analysis. The main instrumentation developments have been in research labs, though this is increasingly being performed by specialised analytical chemistry start-ups or vendors. However, data processing and analysis, as well as

database generation and curation, remain major fields of research. "Ion-mobility spectrometry should be understood as a complementary tool for specific molecules," Cumeras explained. "It will help the clinical laboratory testing units to improve the analysis speed, the specificity, and maybe the cost."

New applications

IMS has opportunities in healthcare because different IMS instrumentations exist, with each using different ways to generate the electric field, including drift tube IMS (DTIMS), field asymmetric IMS (FAIMS), traveling wave IMS (TWIMS), trapped IMS (TIMS), and differential mobility analysers (DMA).

"FAIMS have been shown as a great option for portable in-field instrumentation (GC-IMS) while the others are mainly hyphenated to a mass spectrometer," she said. "These will lead to point-of-care application for FAIMS, like breath analysis or infection determination, while the rest are being applied to other diseases that do not need the patient to be in the office."



GC-IMS: FlavourSpec from GAS

A new application of IMS for pathology is also under development in several research labs.

"Ion-mobility has an exciting future, as disease specific applications are developed and most importantly, validated," she confirmed. In some areas, patients are already feeling the benefits of IMS. One available instrument, based on IMS, is the Edmon, an exhaled drug monitor of propofol, for patients receiving anaesthesia or sedation.



PROFILE

Dr Raquel Cumeras is a Marie Curie postdoctoral fellow at the Institute of Health Research Pere Virgili (IIPSV), and affiliated to the University Rovira i Virgili (URV) at the Department of Electrical Electronic Engineering and Automation in Tarragona, Spain. Her research interests are in data learning for metabolomics, understood as the intersection of metabolomics, signal processing, meta-analysis, and machine learning for clinical applications.

POCT



Lifotronic

nova[®]
biomedical



QUIDEL

 **SARSTEDT**

SIEMENS
Healthineers

Blood Glucose
Immunoassays
Cardiology
Blood Gases /
Electrolytes / Oximetry
Urinalysis
Information Technology
Endocrine
Clinical Chemistry
Other

Blood Glucose

Nova Biomedical – StatStrip Glucose/Ketone*



- Highlights:** The only glucose meter technology cleared by the US FDA across all professional and healthcare settings, including critical care.
- Measures and corrects glucose errors caused by abnormal haematocrit levels
 - Measures and corrects errors caused by electro-chemical interferences
 - Measures blood beta-hydroxybutyrate, the preferred ketone for diagnosing ketoacidosis
 - Available as a fully connected, wi-fi meter, or a smaller Xpress* style meter
- *StatStrip Glucose only in the US*

Siemens Healthineers – DCA Vantage Analyzer



Dimensions: 287 × 254 × 277 mm (w × h × d)
Weight: 3.88 kg

- Highlights:** The DCA Vantage Analyzer makes in-office diabetes testing easy, with accurate, clinically trusted results shown to improve decision making, patient compliance, and outcomes. Get precise HbA1c, albumin, creatinine, and A:C ratio results in minutes with good correlation to laboratory methods and simplify management for POC coordinators with advanced operator, data-management, and security capabilities.
- Product availability varies by country.*

Immunoassays

Lifotronic – FA-160 Immunofluorescence Analyzer



- Highlights:**
- Immunoassay-based diagnostic system
 - Wide diagnosis application: cardiac diseases, lung diseases, infectious diseases, diabetes, etc
 - Easy operation: no sample pre-treatment required
 - 6 incubation channels with auto timing reminder
 - 3-15 min / test
 - Precision CV ≤ 15%; repeatability: CV ≤ 15%, stability: CV ≤ 5%
 - Automatically load lot & RFID card and the scanner
 - High data storage: 10,000 test results
 - Most popular parameters are available

Lifotronic – SARS-CoV-2 Antigen



- Highlights:**
- Multiple sample type: Nasopharyngeal swab / Nasal swab / Saliva
 - Both professional use and self-testing are available, no limitation on scenarios
 - Specific detection: Nucleocapsid(N) protein for antigen test
 - Quick result: test can be finished in 15 min
 - High accuracy: sensitivity ≥ 95%; specificity ≥ 98%
 - Operator-friendly
 - Room temperature transportation and storage



© Shutterstock / Chakraborty Kanta

Emerging technologies in POCT

Considerable advances in point-of-care testing (POCT) devices are emerging from lab-on-a-chip platforms, innovations in smartphone-based technology and wearable technology. Cloud-based deep learning systems herald a future revolution, writes Bernard Banga.

Surging POCT demand

POCT systems account for 30% of in-vitro diagnostics. According to Reportlinker, the global POCT market is anticipated to experience rapid growth in a few years – estimated to reach USD 50.6 billion by 2025, from USD 29.5 billion in 2020 – a CAGR of 11.4%.

Fifteen key market players: Abbott Laboratories (US), Roche Holding AG (Switzerland), Siemens Healthineers AG (Germany), Danaher Corporation (US), Becton Dickinson and Company (US), Johnson & Johnson (US), Instrumentation Laboratory Company (US), PTS Diagnostics Inc (US), Quidel Corporation (US), Chembio Diagnostic Systems Inc (US), Sekisui Diagnostics LLC (US), Nova Biomedical Corporation (US), EKF Diagnostics Holdings plc (UK), AccuBioTech Co., Ltd (China) and Trinity Biotech Plc (Ireland).

Anticipated 2022 revenues by product in the POCT market: glucose monitoring (39%), blood gas analysis (15%), cardiac markers (13%), infectious diseases (8%), pregnancy & fertility testing (5%), alcohol & drug abuse (5%), haemoglobin testing (4%), cholesterol testing (3%), urine chemistry (3%), tumour markers (3%), others (2%).

"The World Health Organisation (WHO) has endorsed bedside diagnostics as the top research priority in response to the so-far 2-year long epidemic without let-up. The aim is to improve turnaround time and ease of use compared to the gold standard lab-based PCR test. These have included rapid antigen tests, alternate nucleic amplification methods and novel sensors in proximity to the patients.

POCT deployed in multiple clinical contexts in 2021

POCT is being rolled out in various healthcare settings in 2021. The most obvious applications are blood-glucose monitoring and pregnancy testing. "Widespread POC testing and diagnostic devices are available, including, but not limited to, glucose monitoring, pregnancy and infertility testing, infectious disease testing, cholesterol testing and cardiac markers," said Amit Saha, from the Stanford Genome Technology Center in California. Today, blood gas analysis along with haemoglobin, prothrombin time and infectious disease testing are the dominant applications in the POCT market. Looking to the future, tumour markers, flow cytometry (mainly for chemotherapy monitoring), endocrine function tests and therapeutic drug monitoring will all benefit from recent technological advances in the POCT field.

Technology advances change POCT applications

Miniaturisation in chip technology, microfluidics and new biosensors have heralded the design of new systems for POCT. Lab-on-a-chip technology is one of the main drivers of POCT, especially in infectious disease diagnosis. This technology means various bioassays, such as microbiological culture, polymerase chain reaction (PCR) and enzyme-linked immunosorbent assay (ELISA), can now be used at the point of care. Similarly, emerging microfluidic technologies include a set of miniaturised components allowing chemical or biological samples to be analysed at the microscopic level. Microfluidic-based POCT devices are widely used in molecular biology as well as in chemical and biochemical analysis. They enable detection and fluid regulation in a single unit. "Greater sensitivity and specificity when detecting target analytes in small volumes overcomes several challenges encountered when using traditional POCT techniques," Saha said. POCT currently centres around two technologies: lateral flow assay (LFA) and nucleic acid amplification. The first is used in pregnancy testing; testing for HIV, herpes simplex virus, hepatitis, infectious diseases (Ebola, dengue, malaria, Zika virus) and respiratory infections; and for diagnosis and prognosis in conditions such as cancer, by identifying specific biomarkers. The second, much more sensitive and specific, is based on polymerase chain reactions (PCR) on a chip and isothermal amplification. Nucleic acid amplification can be used to detect a whole array of infectious diseases, such as *Mycoplasma pneumoniae*, *Bordetella pertussis*, *Legionella pneumoniae*, Influenza A virus, SARS, *Legionella*, *Aspergillus*, West Nile Virus and, now, SARS-CoV-2.

A seventh format joins POCT

POC device manufacturers are continually looking for ways to design products that deliver greater user comfort in a cost-effective manner. POCT relies on six main formats: bench-top, monitoring, transportable, portable, handheld and disposable. In recent years, the latest advances have seen the launch of a seventh: smart devices with smartphones and wearable devices. Mobile POCT uses sensors to detect signals from samples in vitro, whereas wearable POCT detects signals directly on the body. Both systems then send quantified results to the clinic via wireless communication. Various body fluids such as tears, urine, blood, sweat and saliva can be used to analyse metabolites, hormones, proteins, viruses and bacteria. "Smartphones act as minicomputers for sensitive and specific data quantification with built-in sensors, high resolution cameras, rapid wireless connectivity and the ability to use various software and apps. This means they can function as standalone sensors and detectors in mobile POCT," Saha pointed out. Similarly, wearable POCT devices can be physical sensors used to acquire samples from the skin, eye or mouth with minimal invasion. They come in various forms, such as tattoos, patches, bands, watches, spectacles and contact lenses, and can be integrated with smartphones for data capture. This type of testing is

especially important for patients suffering from critical conditions, as they can monitor their health constantly without the need to go to hospital, or for trained personnel.

Artificial intelligence and machine learning

Artificial intelligence (AI), machine learning (ML) and neural networks are now starting to be integrated into POCT. These AI modules have demonstrated their value in diagnostics studies. However, the accuracy of test apps varies greatly and relying on these apps is cautioned against. The future is bright. Since samples can be digitised directly at the point-of-care (POC), advanced digital diagnostic techniques, such as sample analysis using medical AI algorithms, can be deployed outside high-end laboratories. "Hence POC digital microscopy, supported by automated digital image analysis and AI, might be deployed for routine microscopy diagnostics on samples harvested during cancer surgery, or on parasitology samples with an emphasis on potential areas of application in low-resource settings," added Oscar Holmström from the Faculty of Medicine at the University of Helsinki.



POCT and Covid-19

Most promising SARS-CoV-2 POCT methods: immunoassays for antibody and antigen detection, RT-PCR as the gold standard, isothermal amplification and CRISPR/Cas9 genome editing technology as an emerging technique. Due to growing confirmed COVID-19 cases globally, rapid and reliable POCT is needed urgently for early detection. A reliable POCT device could reduce transportation, risk of spreading infection, strain on healthcare, and cost of care.

Despite outbreaks caused by infectious viral diseases such as MERS, SARS, and Ebola, existing POCT platforms were not sufficiently ready to address the COVID-19 viral threat. However, in 2020 great efforts were made in POCT to improve COVID-19 detection.

Immunoassays

Lifotronic – SARS-CoV-2 Antibody Detection Kit



- Highlights:**
- Neutralization Antibody Detection Kit
 - IgG / IgM Antibody Detection Kit
 - IgG/IgM test for the auxiliary diagnosis of COVID-19
 - Neutralization Ab test for monitoring vaccine efficacy and determining immunity levels
 - Cost-effective solution for large-scale testing
 - Quick result: test can be finished in 10 min
 - Operator-friendly
 - Room temperature transportation and storage

Quidel – Sofia 2 – Fluorescent Immunoassay Analyzer



- Dimensions:** 120 × 120 × 220 mm (h × w × d)
Weight: 1 kg
Assays: C. difficile GDH+Toxin*, Influenza A+B & SARS-CoV-2, RSV, Strep A, Legionella, S. pneumoniae, Lyme, SARS-CoV-2 Antibody IgG*
*New test in development

- Highlights:** Proven lateral-flow technology, proprietary advanced fluorescence chemistry and assay development techniques, all in a small bench-top analyzer that can be used near patient and in laboratory settings.
- Intuitive, fast and easy-to-use interface allows operator to quickly run patient samples or navigate stored data
 - Test results in as few as 3 – 15 min (depends on assay)
 - Hands-on-Time: < 1 min
 - Walk Away- and Read Now-mode can be used depending on workflow requirements
 - Room temperature storage

Cardiology

Quidel – Triage MeterPro



- Assays:** High Sensitivity Troponin I, BNP, NT-proBNP, Troponin I, D-dimer, CK-MB, Myoglobin, PLGF, qualitative Drug Screen (urine)
- Highlights:** Quidel Triage MeterPro is designed to provide diagnostic results quickly and easily. With a variety of immunoassays the Quidel Triage MeterPro gives you a flexible solution at the point-of-care.
- Quantitative test results in about 15 – 20 minutes
 - Single- and multimarker panels available
 - Built in quality controls into the meter, software, and test device
 - Interface with any LIS solution
 - Can improve clinical, economic and operational outcomes

Siemens Healthineers – Atellica VTLi



- Assays:** hs-cTnI
Dimensions: 85 × 52 × 250 mm (w × h × d)
Weight: 0.46 kg

- Highlights:** The Atellica VTLi Patient-side Immunoassay analyzer delivers lab-comparable, hs-cTnI results in 8 minutes on a fingerstick sample at the point of care. Leverage cardiac solutions that offer both speed and accuracy from the laboratory to the point of care.

Cardiology

Siemens Healthineers – Stratus CS 200 Acute Care Diagnostic System



Assays: Troponin I, D-dimer, NT-proBNP, CKMB, hsCRP, Myoglobin, bhCG

Dimensions: 460 × 580 × 710 mm (w × h × d)

Weight: 68 kg

Highlights: The Stratus CS 200 Acute Care Diagnostic System delivers lab-quality results at the point of care with the speed that is needed for cardiac patients. Its broad menu of tests helps physicians to make more timely assessments, enabling rapid decision making for better patient care.

Not available for sale in the U.S. Product availability varies from country to country and is subject to local regulatory requirement.

Blood Gases/Electrolytes/Oximetry

KABE Labortechnik – Consumables for blood gas analysis



Highlights: The best sampling system in every situation

Plastic blood gas capillary:

- Unbreakable plastic
- Fast drawing
- Crystal clear
- Numerous drawing volumes and diameters available
- Minimum gas permeability for oxygen and carbon dioxide
- Comprehensive range of accessories

Blood gas tube:

- Rapid anticoagulation thanks to liquid preparation
- Optimal filling with special piston geometry
- Individual sterile packing

Both sampling systems are prepared with balanced heparin and are ideal for blood gas and electrolyte analyses on all common blood gas systems.

KABE Labortechnik – Pipette-Adapter for Capillaries (PAC)



Highlights: Assists in the handling of capillaries and their targeted draining on POCT-analysers and test strips or into vessels

- Suitable for different capillaries regarding measurements and preparations
- Available individually or completed with capillary

Handling:

- Fix capillary in the PAC while using oneway gloves
- The capillary is filled as usual – afterwards the thumb is put gently on the upper mouth of the PAC
- The (dropwise) draining is carried out by generating a slight gauge pressure with the thumb

Nova Biomedical – Prime Plus Critical Care Analyser



Assays: PO₂, PCO₂, pH, Hct, tHb, MCHC, Na, Cl, K, iCa, TCO₂, iMg, Glu, Lac, Urea (BUN), Creat, ePV, SO₂%, O₂Hb, COHb, MetHb, HHb, HbF*, tBil*

Highlights: Stat Profile Prime Plus offers a complete test menu panel in about one minute, along with bidirectional connectivity, a robust data management system, and comprehensive cybersecurity protection.

This comprehensive critical care menu includes iMg, urea and creatinine and calculated tests for ePV, MCHC and OI.

*Not available in the US or Canada

Blood Gases/Electrolytes/Oximetry

Siemens Healthineers – epoc Blood Analysis System

Assays:

pH, pCO₂, pO₂, TCO₂, Na⁺, K⁺, Ca⁺⁺, Cl⁻, Hct, Glu, Lacm Crea, BUN

Dimensions:

Host: 78 × 160 × 16 mm (w × h × d)
Reader: 85 × 50 × 215 mm (w × h × d)

Weight:

Host: 0.25 kg / Reader: <0.5 kg



Highlights: The epoc Blood Analysis System with epoc NXS Host is a market-first to be powered by Android. The System provides comprehensive critical care results at the patient's side in less than 1 minute and is integrated for patient safety. The system delivers a streamlined patient testing process that advances care delivery and accelerates clinical decisions while empowering the laboratory and caregivers to optimize their use of time and resources. It also serves as the nexus of care—connecting the patient and test results to caregivers and the laboratory and delivering a complete, comprehensive clinical picture.

Product availability varies by country

Siemens Healthineers – RapidLab 1200 Blood Gas System



Assays:

pH, pCO₂, pO₂, Na⁺, K⁺, Ca⁺⁺, Cl⁻, Glu, Lac, Neonatal Total Bilirubin, CO-oximetry

Dimensions:

230 × 240 × 610 mm (w × h × d)

Weight:

2.5 kg

Highlights: Siemens RAPIDLab 1200 Blood Gas System is uniquely designed to meet high-volume critical-care testing needs. The system has an ultra-fast sample processing and microsample capability, with results in 60 seconds. Cartridge-based reagent system simplifies operation, and Ready Sensor technology offers reliability with minimal maintenance.

Product availability varies by country.

Siemens Healthineers – RapidLab 348EX Blood Gas System



Assays:

pH, pCO₂, pO₂, Na⁺, K⁺, Ca⁺⁺, Cl⁻, Hct

Dimensions:

385 × 382 × 353 mm (w × h × d)

Weight:

9.4 kg

Highlights: The RAPIDLab 348EX Blood Gas System is a cost-effective solution for low-volume laboratory settings. Report accurate patient results from a whole-blood sample in 60 seconds, with minimal operator interaction. Increase operator efficiency with bar-code data entry of patient and operator IDs, automatic sample aspiration and calibrations.

Not available for sale in the U.S.
Product availability varies by country.

Siemens Healthineers – RapidPoint 500e Blood Gas System



Assays:

pH, pCO₂, pO₂, Na⁺, K⁺, Ca⁺⁺, Cl⁻, Glu, CO-oximetry, Lac

Dimensions:

300 × 550 × 420 mm (w × h × d)

Weight:

16.55 kg

Highlights: The RAPIDPoint 500e Blood Gas System features a redesigned user interface and upgraded hardware and software to deliver an intuitive, heightened user experience. It incorporates Siemens Healthineers proprietary Integri-sense technology to deliver confidence with every result and elevates blood gas solution to a new level, allowing more time for patient care.

Product availability varies by country to country.

Urinalysis

Siemens Healthineers – Clinitek Status Connect System



Assays: Albumin, Bilirubin, Creatinine, Glucose, Ketone, Leukocytes, Nitrite, pH, Protein, Specific gravity, Urobilinogen, Albumin-to-creatinine, hCG

Dimensions: 171 x 185 x 272 mm (w x h x d)

Weight: 2.3 kg

Highlights: The CLINITEK Status Connect System with Auto-Checks Technology simplifies and streamlines your daily operations. This automated point-of-care urinalysis and hCG pregnancy testing solution eliminates the subjectivity of a visual read, helps improve accuracy, saves time, and allows for increased productivity. This system provides flexible data management and connectivity through bi-directional connectivity and on-board Wi-Fi with expanded network compatibility.*

*Feature not available in all countries.

Siemens Healthineers – Atellica 1500 Automated Urinalysis System



Sample Throughput: 106 – 240 samples/h

Assays: Bilirubin, Clarity, Color, Glucose, Ketone, Leukocyte esterase, Nitrite, Occult blood, pH, Protein, Specific gravity, Urobilinogen, Albumin, Albumin-to-creatinine ratio, Creatinine, Protein-to-creatinine ratio

Dimensions: 1260 x 625 x 680 mm (w x h x d)

Weight: 114 kg

Highlights: Combining the CLINITEK Novus Analyzer and the Atellica UAS 800 Analyzer* into one completely automated unit, the Atellica 1500 Automated Urinalysis System sets the new standard for accuracy and efficiency. It is a truly digital automated urinalysis system, and lets you manage more samples with less staff in shorter time, while never compromising on high-quality results.

Not available for sale in the U.S. Product availability varies by country.

Information Technology

Siemens Healthineers – POCcelerator Data Management System



Highlights: Connect securely with an open, reliable POC informatics platform. Gain vendor independence and free choice in selecting the appropriate POCT device to meet your clinical requirements. Confirm that your POC devices are online, operational, and properly maintained with immediate oversight and control. Includes data analytics, operator management, quality assurance, and eLearning integration. Create a long-term solution that saves time and money by simplifying the complexity and cost of maintaining multiple IT systems.

Product availability varies by country.

Endocrine

Nova Biomedical – Allegro* – a fast simple capillary blood analyser



Assays: HbA1c, Lipids panel, PT/INR, CRP, blood glucose and creatinine, urine albumin and creatinine

Highlights: Allegro* offers a clinically important menu of 10 measured and individually selectable tests, plus 7 calculated tests. All tests are measured with disposable, ready-to-use cartridges or test strips, and are easily performed by non-technical personnel.

- Capillary fingerstick samples for all blood tests
- Immediate test results during the patient visit
- Reduces patient follow-up visits and costs

*Not available in the US or Canada

Clinical Chemistry

Nova Biomedical – StatSensor Creatinine



- Highlights:** Fingerstick capillary testing for creatinine
- The StatSensor Creatinine is a handheld analyser and miniaturized, single-use biosensor for whole blood creatinine testing. StatSensor Creatinine's advanced technology enables simple, rapid, and accurate assessment of renal function by fingerstick capillary blood sampling at the point of care. Available as a fully connected meter, or a smaller Xpress* style meter.
- Capillary sampling
 - Creatinine and eGFR results in 30 seconds
 - 1.2uL sample
 - Calculates eGFR by CKD-EPI and MDRD equations
- *Not available in the US and Canada*

Other

Nova Biomedical – StatStrip Lactate / Haemoglobin/Haematocrit*



- Highlights:** Fingerstick capillary testing for Lac, Hb, and Hct
- The StatStrip LAC / Hb / Hct is a handheld, easy-to-use meter that measures lactate, haemoglobin and haematocrit at the point-of-care using two disposable biosensors and tiny capillary blood samples for all tests. Available as a fully connected, wi-fi meter, or a smaller Xpress style meter.
- Capillary sampling
 - Measured Hb and measured Hct in 40 seconds from 1.6µL blood
 - Measured lactate in 13 seconds from 0.6 µL blood
- *StatStrip Lactate only in the US and Canada*

Nova Biomedical – Stat EMS*



- Highlights:** Lactate, haemoglobin, haematocrit, glucose, and ketone for early patient assessment and treatment
- Fingerstick capillary sample
 - Results as fast as 6 seconds
 - Laboratory-quality accuracy
 - Durable carrying case holds meters, single-use biosensors, controls, and lancets
- Stat EMS* offers simple, fast, and accurate testing in the field. Two meter systems are available. One provides patient data storage plus wireless connectivity to external data managers, the other provides data storage only.
- *Not available in the US and Canada*

Sarstedt – Minivette POCT / Capillary Blood Collection



- Highlights:**
- Collection devices for Point-of-Care tests
 - Easy sample recovery
 - Precise and dispensing of small whole blood volumes
 - Prevents spillage during transfer
 - Volume range: 10 µl – 200 µl
 - Preparations: neutral, heparin and EDTA

Information Technology

LIS/Middleware/POCT
Inventory Management



LIS/Middleware/POCT

Beckman Coulter – DxONE Command Central Workstation



Highlights: Beckman Coulter's DxONE Command Central remote monitoring system helps manage lab workflow and improve decision-making steps. The system can connect up to 18 instruments or automation systems, and up to five networked DxONE Command Central workstations within a single laboratory, allowing the operator to place DxONE Command Central workstations in prime laboratory locations for increased flexibility.

DxONE Command Central maximizes workflow efficiencies by providing lab technicians with a real-time view of laboratory systems from a single point of control. DxONE Command Central works with data managers such as Remisol Advance to achieve workflow efficiencies, or can serve as a stand-alone product for users to monitor automation and/or multiple analyzers and quickly respond to any instrument issues.

Beckman Coulter – Remisol Advance



Highlights: Remisol Advance is an enterprise data management solution that can help improve sample workflow through consolidated management, drive consistency through network standardization across multiple sites, create efficiency through autoverification, and improve reliability by integrating quality control management. It is a unique software product that consolidates patient test information from multiple instruments in the lab or from multiple labs in the hospital network. Remisol Advance features virtualization capability to help reduce failure points and increase uptime.

CliniSys | MIPS – MIPS vianova Labor



Highlights: MIPS vianova Labor – high efficiency, rapid communication of results, standardised workflows
MIPS vianova Labor is a unique, patient-oriented LIS system that allows users to manage a wide range of laboratory processes, simply through configuration. It's the ideal solution wherever high efficiency and rapid information availability are needed. MIPS vianova Labor is a multidisciplinary LIS that offers complete support for all key disciplines as clinical chemistry, blood bank, microbiology, hygiene, veterinary medicine.

CliniSys | MIPS – GLIMS



Highlights: GLIMS – the most widely used LIS in Europe
GLIMS is a high-performance laboratory information system (LIS) that allows you to organise and automate all processes exactly as you want them: from order entry and instrument control to results reporting, invoicing and statistics. Thanks to the rich functionality of GLIMS, your laboratory can work more efficiently. You save costs and resources, while offering an enhanced service for requesters and patients – today and tomorrow.

LIS/Middleware/POCT

CliniSys | MIPS – GLIMS Genetics



GLIMS Genetics

- Complete genetics workflow
- Family management with a drawing pedigree solution
- High-level automation
- Shortest configuration time

Highlights: GLIMS Genetics – digital workflows for the entire genetic spectrum

GLIMS Genetics covers the entire genetic spectrum including the latest methods such as next-generation sequencing. It can be used as a standalone solution with a gene panel and variant results management, interconnected with other LIS systems and essential interfaces to all common expert systems. It can also be configured as part of a complete diagnostics LIS or be connected to order entry and result reporting systems such as CyberLab.

CliniSys | MIPS – CyberLab



CyberLab

- Easy, error-free order entry
- Flexible sample collection workflows
- Feature-rich result consultation
- Intelligent and secure guidance

Highlights: CyberLab – streamline communications between healthcare providers and laboratories

CyberLab is a customisable, intelligent order entry and result consultation solution, helping you provide high quality patient care. Clear, fast and correct communication between care providers and laboratories is key in enabling high-quality patient care. From order entry, through sample collection, to result consultation, CyberLab keeps you connected – anytime, anywhere.

i-Solutions Health – LabCentre



Highlights: LabCentre is a laboratory and pathology information management system. It helps doctors, scientists, technologists and management staff to track samples and testing processes, communicate results to other health professionals, and monitor costs and reporting.

LabCentre supports the following disciplines:

- Blood sciences
- Microbiology
- Hygiene
- Transfusion medicine
- Pathology
- Billing

Medat – Laboratory Information System



Highlights:

- Complete solution from order entry to billing.
- Highly customisable modules for microbiology, virology, environmental hygiene, cytopathology, histopathology, clinical chemistry, serology/toxicology, blood bank and human genetics.
- Single, integrated system for all divisions and sites.
- Reliable operation in some of Europe's biggest laboratories.

LIS/Middleware/POCT

Siemens Healthineers – Atellica Process Manager



Highlights: Uncover inefficiencies and optimize clinical operations with built-in analytics and business intelligence. Identify and resolve pre-analytic, analytic and post-analytic problems with advanced performance metrics. Increase productivity with centralized oversight to control systems*, view reagent levels and review exceptions from one screen. Deliver transparent, predictable TAT using rules and at-risk sample alerts.

*Instruments require VNC or Remote Desktop capability. Not available on all systems.

Siemens Healthineers – Atellica Data Manager



Highlights: Open, scalable, easy-to-use solution with powerful rules to standardize testing, enhance QC and streamline result management. Enhance visibility, automate processes, autoverify results and centralize management of analyzers, automation, sites and networks to increase productivity. Reduce errors and process variation with consistent review/reporting. Sharpen clinical focus with details needed to make informed, accurate decisions.

Product availability varies by country.

Inventory Management

Siemens Healthineers – Atellica Inventory Manager



Highlights: Get the right materials at the right time – Atellica Inventory Manager* provides automated, real-time control of reagents and consumables across multiple locations to reduce costs, save time, and improve lab quality.

*Product availability varies by country.



Integrated
solution management
for your laboratory

dr. neumann&kindler

www.labcore.de

Other Applications

Blood Collection
Pipette Tips
Saliva Collection
Centrifuges
Nitrogen Generators
Compressors
Incubators
Freezers
Clean Benches
Specialties



Other Applications

Blood Collection

Greiner – Vacuette Safety Blood Collection Sets



- Highlights:**
- Specially developed for blood collection from patients with difficult vein conditions
 - Protection from the risk of needlestick injuries
 - Simple activation of safety mechanism
 - Transparent view window provides clear vein entry indication
 - Particularly safe due to activation of the safety mechanism while the needle is still in the vein
 - More flexibility due to assorted tube lengths for blood collection
 - Optional use as an infusion set

KABE Labortechnik – Capillary Blood Collection GK



- Highlights:** Capillary Blood Collection GK – for small amounts of blood
- The system offers special advantages for the collection of blood samples from new-borns, children, elderly people and emergency patients, thus everywhere, where only small amounts of blood are available
- The test vessel is prepared on the entire inner surface. Besides it can be used as centrifugal vessel
 - The capillary is coated on the entire inner surface and guarantees an exact filling volume
 - The attached stopper, which is optionally available with an integrated elastically resealable rubber membran, offers perfect tightness
 - Different measurements and preparations are available

KABE Labortechnik – Primavette S and V



- Highlights:** The safe and variable blood collection system
- Gentle – aspiration technique suitable for all vein conditions
 - Safe – unbreakable, high quality plastic ensures maximum user and patient safety
 - Clean – the high grade rubber membrane closure guarantees absolute tightness
 - Flexible – vacuum technique possible
 - Versatile – available in different tube sizes and preparations
 - Comprehensive – offered with a broad range of accessories

KABE Labortechnik – Consumables Test Tubes



- Highlights:** Test tubes and reaction vessels in various dimensions and versions
- Different sizes and bottom shapes
 - Various stopper types and colours, such as screw caps, pressed-on stoppers and more
 - Tubes available with (individual) label with/without barcode and tear-off label
 - Tubes with preparations for common blood analyses available, such as serum and plasma collection or haematological analyses
- Furthermore: precise filling of customers' reagents possible on in-house filling-systems

Blood Collection

Sarstedt – Multi-Safe Disposal Boxes



- Highlights:**
- Our wide, tailor-made range of Multi-Safe disposal boxes corresponds to the current ISO 23907-1:2019 on the prevention of needle stick injuries.
 - With our extensive product range of Multi-Safe boxes we are able to meet any disposal need in the field of medicine and laboratory.
 - With the various options, from the convenient 200 ml format to the autoclavable 60 l disposal box for clinical waste, we offer an optimal solution for every need.

Pipette Tips

Sarstedt – Low Retention Pipette Tips



- Highlights:**
- Minimising sample loss
 - Optimised surface for enhanced dispensing behavior
 - Improved sample recovery
 - Minimal sample loss of highly viscous liquids or samples containing detergents
 - Cost savings in valuable reagents

Saliva Collection

Sarstedt – COVID-19 virus diagnostics products



- Highlights:**
- Validated containers for saliva collection for virus diagnostics: Monovette VD, V-Monovette VD and Salivette VD.
 - Saliva testing has become particularly important and is ideal for screening for SARS-CoV-2. Saliva collection using gargling and /or the Salivette offers the key advantage that the user can collect the saliva themselves under supervision.
 - Both the gargling and the Salivette saliva collection methods are a more pleasant experience for the patient than the commonly used nose and throat swab method.
 - The sample collected can be transported to the laboratory securely sealed in a secondary container.
 - Acute infections can be directly detected using the molecular biological PCR method. There are also rapid tests that use saliva as the sample material.

Centrifuges

Hettich – Mikro 220 | 220 R

- Dimensions:**
330 × 420 × 313 mm (w × h × d)
- Weight:**
21 kg / 42 kg
- Rotational frequency:**
18,000 min⁻¹
- Relative centrifugal force:**
31,514



- Highlights:**
- Compact, high-performance microlitre centrifuge
 - Choice of seven rotors
 - IvD-conform according to directive 98/79/EC
 - Impulse key for short cycle mode
 - Nine program memories for more individuality
 - Nine individual acceleration and deceleration stages
 - Model 220 R coolable from -20 to +40 °C with pre-cooling function
 - Max. number of tubes: 60 × 2.0 ml

Other Applications

Centrifuges

Hettich – Universal 320 | 320 R

Dimensions:

401 × 529 × 346 mm (w × h × d)

Weight:

31 kg / 52 kg

Rotational frequency:

16,000 min⁻¹

Relative centrifugal force:

24,900



Highlights:

- The universal choice among the benchtop centrifuges
- Choice of 18 rotors
- IVD-conform according to directive 98/79/EC
- Impulse button for short centrifugation
- Impulse key for short cycle mode
- Nine program memories
- Nine individual acceleration and ten deceleration stages
- Model 320 R coolable from -20 to +40 °C with pre-cooling function
- Max. number of tubes: 4 × 200 ml / 6 × 94 ml

Hettich – Rotina 420 | 420 R

Dimensions:

506 × 650 × 423 mm (w × h × d)

Weight:

75 kg / 108 kg

Rotational frequency:

15,000 min⁻¹

Relative centrifugal force:

24,400



Highlights:

- High-performance with first-class equipment
- Choice of five rotors
- IVD-conform according to directive 98/79/EC
- Max. noise level of 51 dB(A) with rotor 4790-A
- 98 program memories for more individuality
- Nine individual acceleration and deceleration stages
- Model 420 R coolable from -20 to +40 °C with pre-cooling function
- Max. number of tubes: 4 × 600 ml

Sarstedt – SC 2700 Centrifuge



Highlights:

- Centrifugation at up to 2,700 × g with swing-out rotor
- Easy operation with pre-installed programs
- Variable program for individual settings is available
- High quality and quiet

The SC 2700 centrifuge has been specially designed for use in physician's consultancies or small laboratory units and can be used with all standard samples tubes.

Intuitive operation to centrifuge the most common types of sample materials at the push of a button is guaranteed by pre-set programs for blood and urine.

The settings tailored to the specific sample materials of blood and urine make it virtually impossible to operate the centrifuge incorrectly.

Thermo Fisher – Thermo Scientific 1.6l and 4l Plus Centrifuges



Highlights:

- Spin up to 76 × 5/7 ml blood tubes in a 1.6l footprint or up to 196 × 5/7 ml blood tubes in a 4l footprint
- ClickSeal biocontainment lids provide added safety
- Benchtop and floor-standing options available to fit every lab
- High contrast user interface for up to 6 saved programs for routine applications
- Quick rotor removal with Auto-Lock rotor exchange for easy cleaning
- Ergonomic designs
- Available in ventilated and refrigerated models
- Versatile rotor / adapter solutions for numerous applications

Centrifuges

Thermo Fisher – Thermo Scientific Small Bench Centrifuges



- Highlights:** Compact centrifuges designed for effective and efficient processing of clinical samples.
- Accommodate up to 24 × 5/7 ml blood tubes
 - Store up to 99 pre-saved protocols
 - ClickSeal biocontainment lids provide added safety
 - Flexibility to spin a variety of vessels such as micro-plates, shell vials and urine tubes

Thermo Fisher – Thermo Scientific Medifuge Clinical Centrifuges



- Highlights:** Optimize your workflow with the unique "2-in-1" hybrid design of the Thermo Scientific DualSpin rotor.
- 8-place interchangeable fixed angle and swinging buckets
 - Program up to 4 routine protocols
 - Fits into doctor's labs
 - Can spin blood collection, urine or conical tubes as well as shell vials

Thermo Fisher – Thermo Scientific 17 and 21 Microcentrifuges



- Highlights:** Small footprint with outstanding features, suited for molecular diagnostic and pediatric tests.
- Spin up to 24 micro or pediatric tubes in a single run
 - ClickSeal biocontainment lids with transparent design for added safety
 - Available in ventilated and refrigerated models
 - Accommodates microtubes, capillaries and 600 µl blood collection tubes

Nitrogen Generators

Chromalytic – Nitrogen generators for LC-MS



- Nitrogen flow:** up to 64 l/ min at 0 bar
Nitrogen purity: up to 99.5%

- Highlights:**
- Nitrogen generator with integrated compressor HF30A and without compressor HF30N/HF60N available
 - Lowest life cycle costs on the market
 - Oil-free Dürr Technik compressor integrated (HF30A)
 - Easy usability / plug & play
 - Developed for continuous operation

Other Applications

Compressors

Dürr Technik – Sicolab – Compressor stations



Air flow: up to 145 l/min at 5 bar
Compressed air quality: up to 1:3:1 (according to ISO 8573-1)

- Highlights:**
- Oilfree compressed air for many applications
 - Silent – thanks to excellent soundproofing (48 – 54 db [A])
 - Compact – fits under the laboratory bench
 - Mobile – with wheels or handling grips
 - Wide variety of versions
 - Membrane dryer and filters as options

Incubators

Hettich – HettCube 600 R

Dimensions:
710 × 825 × 1990 mm (w × h × d)

Weight:
175 kg

Temperature range:
0 °C to +65 °C

Internal volume:
520 l

Energy consumption at 37°:
0.056 kWh/h



- Highlights:**
- Only 0.6 m² footprint
 - Up to 67 percent of usable volume
 - Fast and easy access, one-hand operation door
 - Perfect conditions with unique temperature regulation
 - Real-time calendar
 - Week programming with holiday function
 - Flexible alarm settings
 - Wide range of program functions (Start after time, start after temperature etc.)
 - Up to four shelves included in standard
 - Automatic door closure with magnetic seals
 - Low noise level of ≤ 44 dB(A)

Freezers

Thermo Fisher – Thermo Scientific Blood Bank Refrigerators



Highlights:

Our high-performance blood bank refrigerators are designed to meet strict requirements established by the AABB and are approved products under their Standards-Compliant Product Evaluation (SCoPE) program for the storage of whole blood and blood components.

- Factory pre-set to 4° C to meet blood storage guidelines
- Heat-free defrost for maximum temperature uniformity
- Convenient, stainless steel, fully extendable and adjustable drawers
- Standard, built-in chart recorder
- GMP Clean Room Class A / ISO 6 (ISO EN 14644-1) compatible with appropriate pre-install preparation

Thermo Fisher – TSX2320FV TSX Series Manual Defrost Freezers



Highlights:

Thermo Scientific TSX Series high-performance -20° C manual defrost freezers are designed with features that support sample protection and sustainability objectives for the storage of clinical and laboratory-grade storage requiring -20° C.

- Whisper quiet with a sound level of 52 dBA, enabling end users to work alongside the refrigerator without distraction
- Unique V-drive technology is designed to detect usage patterns such as door openings when a higher compressor speed is needed and periods of stability where the compressor runs at a lower speed, saving energy without compromising protection
- Up to 50% less energy usage than conventional refrigerant models
- Natural, R290 refrigerants, making the TSX Series compliant with the U.S. Environmental Protection Agency's Significant New Alternatives Policy (SNAP)

Freezers

Thermo Fisher – TSX2330LV TSX Series Plasma Freezers



Highlights:

- Our pre-set, high-performance -30°C plasma freezers with automatic defrost are designed to meet strict requirements established by the AABB and are approved products under their Standards-Compliant Product Evaluation (SCoPE) program for the storage of plasma.
- Forced-air circulation for temperature uniformity and fast temperature recovery
 - Convenient, stainless steel, fully extendable and adjustable drawers
 - GMP Clean Room Class A / ISO 6 (ISO EN 14644-1) compatible with appropriate pre-install preparation
 - FDA listed Medical Device, 510K exempt

Clean Benches

Thermo Fisher – Thermo Scientific Biological Safety Cabinets



Highlights:

- Certified performance and protection that stays with you every day. Not true with ordinary cabinets. The difference is our design.
- Thermo Scientific SmartFlow technology features dual-DC motors to automatically balance the cabinet inflow and downflow air velocities in real time
 - Digital Airflow Verification (DAVe) alarm signals any out-of-spec conditions for added assurance
 - Energy efficient motors and sustainable design provide globally aware world class performance

Specialities

ibidi – Solutions for microcopy and cell-based assays

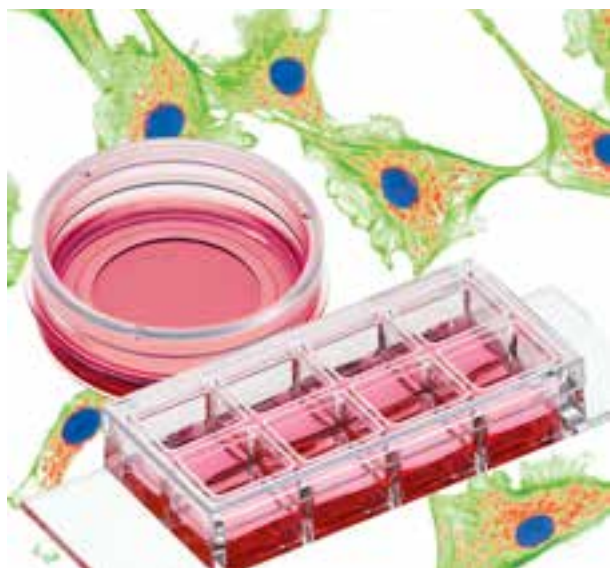

Highlights:

- Cultivate your cells and perform high-resolution microscopy
- Benefit from excellent cell culture conditions on the unique ibidi Polymer Coverslip
- Investigate angiogenesis, chemotaxis, wound healing, and cells under flow
- Available in various open formats or channel slides
- Test with a free sample

Sarstedt – Cell Culture Products











Highlights:









- For over 25 years Sarstedt has produced a wide range of high quality cell culture products which are distributed worldwide. These many years of experience and knowledge of the needs of users have allowed us to optimise and continually expand the product range.

Companies & Suppliers

	Sample Processing	Automation	Chemistry & Immunochemistry	Mass Spectrometry	Hematology	Pathology	DNA	Microbiology	POCT	Information Technology	Other Applications
<p>Alsachim, a Shimadzu Group Company 160 rue Tobias Stimmer 67400 Illkirch, France phone: +33 390 402 200 contact@alsachim.com www.alsachim.com</p>			22								
<p>ASP Lab Automation AG Heinrich-Hertz-Straße 32 25336 Elmshorn, Germany phone: +49 4121 264 731-0 info@asplabauto.com www.asplabauto.com</p>	8										
<p>Beckman Coulter Diagnostics 22, Rue Juste-Olivier 1260, Nyon, Switzerland phone: +41 22 365 38 08 EUPublicRelations@beckman.com www.beckmancoulter.com</p>	14 15		22 23 29 30		48 53					96	
<p>Biomaneó 22B Boulevard Winston Churchill 21000 Dijon, France phone: +33 374 95 08 45 contact@biomaneó.com biomaneó.fr</p>			39	39							
<p>Associates of Cape Cod Europe GmbH Opelstraße 14 64546 Mörfelden-Walldorf, Germany tel +49 61 05 96 10-0 service@acciusa.de www.acciusa.de</p>								80			
<p>Chromalytic LTD Cranleigh Road Fareham PO16 9DR phone: +49 7142 9022-0 office@chromalytic.com www.chromalytic.com</p>											103
<p>CliniSys MIPS MIPS Deutschland GmbH Am Klingenberg 6, 65396 Walluf, Germany phone: +49 6123 7016-222 labor@mips.be www.clinisysgroup.com</p>						60				96 97	
<p>DIRUI INDUSTRIAL CO.,LTD. 3333 Yiju Road, New&High Tech. Development Zone Changchun, Jilin 130103, China phone: +86 431 85083742 dirui@dirui.com.cn en.dirui.com.cn</p>			23 30 43		48						
<p>DRG Instruments GmbH Frauenbergstraße 18 35039 Marburg, Germany phone: +49 6421 1700-0 raeder@drg-diagnostics.de www.drg-diagnostics.de</p>			29								

	Sample Processing	Automation	Chemistry & Immunochimistry	Mass Spectrometry	Hematology	Pathology	DNA	Microbiology	POCT	Information Technology	Other Applications
<p>DTM Medical Mainzer Straße 131 65187 Wiesbaden, Germany phone: +49 611 92777-0 info@dtm-medical.eu dtm-medical.eu</p> 						58 59					
<p>Dürr Technik GmbH & Co. KG Pleidelsheimer Straße 30 74321 Bietigheim-Bissingen, Germany phone: +49 7142 9022-0 office@duerr-technik.de www.duerr-technik.com</p> 											104
<p>FUJIFILM Wako Chemicals Europe GmbH Fuggerstraße 12 41468 Neuss, Germany phone: +49 2131 311-272 diagnostics_wkeu@fujifilm.com www.wako-chemicals.de</p> 			23 24 31								
<p>Genrui Biotech Inc. 4-10F, Building 3, Geya Technology Park Guangming District 518106 Shenzhen, China phone: +86 755 26 83 55 60-1 (-2) international@genrui-bio.com www.genrui-bio.com</p> 			31								
<p>Greiner Bio-One GmbH Bad Haller Straße 32 4550 Krefeld, Germany phone: +43 7583 6791-0 office@at.gbo.com www.gbo.com</p> 			24 43 44		48 54						100
<p>Hamamatsu Photonics Deutschland GmbH Arzbergerstraße 10 82211 Herrsching, Germany phone: +49 8152 375-203 info@hamamatsu.de www.nanozoomer.com</p> 						58					
<p>Andreas Hettich GmbH & Co. KG Föhrenstraße 12 78532 Tuttlingen, Germany phone: +49 7461 705-0 info@hettichlab.com www.hettichlab.com</p> 											101 102 104
<p>Hologic, Inc Heron House, Crewe Road Wythenshawe, Manchester M23 9HZ, Great Britain phone: +44 161 946 2200 euinfo@hologic.com www.hologic.com</p> 	9						70				
<p>Helmut HUND GmbH Artur-Herzog-Straße 2 35580 Wetzlar, Germany phone: +49 6441 2004-0 info@hund.de www.hund.de</p> 								80			

Companies & Suppliers

		Sample Processing	Automation	Chemistry & Immunochemistry	Mass Spectrometry	Hematology	Pathology	DNA	Microbiology	POCT	Information Technology	Other Applications
ibidi GmbH Lochamer Schlag 11 82166 Gräfelfing, Germany phone: +49 89 5204617-0 info@ibidi.de ibidi.com												105
Improve Medical No. 102, Kaiyuan Avenue, Science City, Guangzhou Economic & Technological Development District, Guangzhou, China phone: +86 20 32312610 info@improve-medical.com www.improve-med.com	 HUMAN HEALTH WE CARE	9	15									
i-SOLUTIONS Health GmbH Am Exerzierplatz 14 68167 Mannheim, Germany phone: +49 621 3928-0 info@i-solutions.de www.i-solutions.de											97	
KABE-Labortechnik GmbH Jägerhofstraße 17 51588 Nümbrecht-Elsenroth, Germany phone: +49 2293 9132-0 info@kabe-labortechnik.de www.kabe-labortechnik.de							59			91		100
KUGEL medical GmbH & Co. KG Hermann-Köhl-Straße 2 A 93049 Regensburg, Germany phone: +49 941 208648-0 info@kugel-medical.de www.kugel-medical.de							60					
Lifotronic Technology Co., Ltd 4th Floor, Building 15, 1008 Songbai Road Nanshan District 518055, Shenzhen, China phone: +86 755 29060026 inter-marketing@lifotronic.com en.lifotronic.com				31 32		49 56		63 72		87 90		
Medat Computersysteme GmbH Albrechtstraße 14 80636 München, Germany phone: +49 89 126808-0 vertrieb@medat.de www.medat.de											97	
MEDITE Medical GmbH Wollenweberstraße 12 31303 Burgdorf, Germany phone: +49 5136 8884-0 info@medite.de www.medite.de							61					
SHENZHEN MINDRAY Bio-Medical Electronics Co., LTD. Mindray Building, Keji 12th Road South, High-tech Industrial Park, Nanshan 518057 Shenzhen, China intl-marcom@mindray.com www.mindray.com				24 25 32 33 38		50 53						

	Sample Processing	Automation	Chemistry & Immunochimistry	Mass Spectrometry	Hematology	Pathology	DNA	Microbiology	POCT	Information Technology	Other Applications
MolGen Traverse 2, 3905 NL, Veenendaal, The Netherlands info@molgen.com molgen.com	9 12						63 66 73				
Nova Biomedical 200 Prospect Street Waltham, MA 02454-9141, USA phone: +1 781 894-0800 info@novabio.com www.novabiomedical.com									87 91 93 94		
Olympus Europa SE & Co. KG Amsinckstraße 63 20097 Hamburg, Germany phone: +49 40 23773-0 ScientificSolutions@olympus-europa.com www.olympus-lifescience.com					54	59		80			
Promega GmbH Gutenbergring 10 69190 Walldorf, Germany phone: +49 6227 6906-129 martin.rossmanith@promega.com www.promega.com		15					66				
Quidel Germany GmbH Leibnizstraße 11 70806 Kornwestheim, Germany MarketingEurope@quidel.com www.quidel.com							63		90		
SARSTEDT AG & Co. KG Sarstedtstraße 1 51588 Nümbrecht, Germany phone: +49 2293 305-0 info@sarstedt.com www.sarstedt.com www.tempus600.com	12 13	19	26 29 43 44		50	61	63 73		94		101 102 105
SHIMADZU Europa GmbH Albert-Hahn-Straße 6-10 47269 Duisburg, Germany phone: +49 203 7687-0 shimadzu@shimadzu.eu www.shimadzu.eu			39 40 42 44	39 40 42 75				75			
Siemens Healthineers Laboratory Diagnostics 511 Benedict Avenue 10591 Tarrytown, NY, USA phone: +1 914 631 8000 www.siemens-healthineers.com/laboratory-diagnostics		18	33 38 39 42 43		52 54 55		70 71		87 90 91 92 93	98	
Shenzhen New Industries Biomedical Engineering Co., Ltd. No.23, Jinxiu East Road, Pingshan District 518122 Shenzhen, China phone: +86 755 26501514 sales@snibe.com www.snibe.com			28 33 34				66 68 70 71				

Companies & Suppliers

	Sample Processing	Automation	Chemistry & Immunochemistry	Mass Spectrometry	Hematology	Pathology	DNA	Microbiology	POCT	Information Technology	Other Applications
<p>T&O LabSystems GmbH & Co. KG Leibnizstraße 7 24568 Kaltenkirchen, Germany phone: +49 4191 9913883 info@to-labsystems.com www.to-labsystems.com</p> 	14										
<p>TECO Medical Instruments Dieselstraße 1 84088 Neufahrn, Germany phone: +49 8773 70780-0 info@teco-gmbh.com www.teco-medical.com</p> 					56						
<p>Thermo Fisher Scientific 168 Third Avenue Waltham, MA 02451, USA www.thermofisher.com</p> 											102 103 104 105
<p>Zybio Inc. No. 6 Taikang Road, Block C, Jianqiao Industrial Park, Dadukou District Chongqing, China 400082 phone: +86 23 6869 9779 info@zybio.com · www.zybio.com</p> 	14		28 34 38	80	52		68 70 72	80			

Index of advertisers

Associates of Cape Cod	81
Beckman Coulter	inside front cover
Hologic	49
Lifotronic Technology	73
Mindray	49
MolGen	69
Shimadzu	41
Siemens Healthineers	back cover
Snibe	35
Zybio	27

Imprint

published by

mg^o fach
verlage

MEDIENGRUPPE OBERFRANKEN

Fachverlage GmbH & Co. KG
E.-C.-Baumann-Straße 5
95326 Kulmbach, Germany
Phone: +49 9221 949-311

EDITOR-IN-CHIEF

Markus Neumann
Dr. Neumann & Kindler GmbH & Co. KG
Herner Straße 324
44807 Bochum, Germany
Phone: +49 234 9571969-0
info@labcore.de · www.labcore.de

PUBLISHING DIRECTOR

Mareike Scholze

MANAGING DIRECTOR

Walter Schweinsberg, Bernd Müller

LAYOUT AND GRAPHIC DESIGN

Christoph Muschiol, Seelbach, Germany

ADVERTISING

Gavin Hua (China)
Eric Jund (E, F, I)
Simon Kramer (B, GB, L, NL)
Ralf Mateblowski (D, A, CH)
Jane Park (Korea)
Maria Kaiser, Hanna Politis (U.S.A, Canada)
Charles Yang (Taiwan)

SUBSCRIPTION

Dorothea Fleischer, fleischer@european-hospital.com
Subscription rate: € 15,- plus postage

PRINTED BY

Rehms Druck, Borken, Germany

DISCLAIMER

The information and opinions expressed in articles and product entries published in LABBook are solely those of the manufacturers/companies, their authors and contributors, for which the publisher holds no responsibility.

All trademarks, product names, company names and logos in this publication are the property of their respective holders. Users must obtain permission from those holders before copying or using the owner's trademarks, product and company names or logos.

Errors and omissions excepted.

© 2021 by Mediengruppe Oberfranken, Fachverlage GmbH & Co. KG.
All rights reserved.

We pioneer breakthroughs in healthcare.

For everyone. Everywhere.

siemens-healthineers.com/euromedlab



31-21-DX-1110-76 · © Siemens Healthcare Diagnostics Inc., 2021

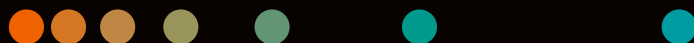

Intelligent, integrated IVD solutions that deliver innovative workflow efficiencies, clinical insights, and digital applications.

Learn more at EUROMEDLAB Munich 2021

Booth #83, Hall C1

29 November–1 December

SIEMENS
Healthineers 